

# APPROVAL SHEET

**WA02B**

**±5%, ±1%**

Thick film

General purpose chip resistors array

Size 0201x2 **Flat Type**

\*Contents in this sheet are subject to change without prior notice.

## FEATURE

1. Small size and light weight
2. Reduced size of final equipment
3. Lower surface mounted assembly costs
4. Higher component and equipment reliability
5. Lead free / Halogen free

## APPLICATION

- Consumer electrical equipment, PDA, Digital Cam-coder, ...
- EDP, Computer application
- Mobile phone, Telecom
- Ram module

## DESCRIPTION

The resistors array is constructed in a high grade ceramic body (aluminum oxide). Internal metal electrodes are added at each end and connected by a resistive paste that is applied to the top surface of the substrate. The composition of the paste is adjusted to give the approximate resistance required and the value is trimmed to within tolerance by laser cutting of this resistive layer.

The resistive layer is covered with a protective coat. Finally, the two external end terminations are added. For ease of soldering the outer layer of these end terminations is a Tin (lead free) solder alloy.

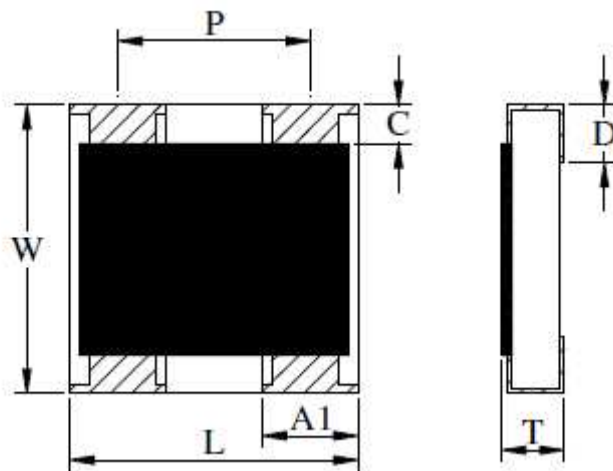

Fig 1. Outline of chip-R array WA02B

**QUICK REFERENCE DATA**

Item	General Specification
Series No.	WA02B
Size	0201x2 (0603x2)
Termination construction	Flat type
Resistance Tolerance	±5%, ±1% (E24 series)
Resistance Range	±5%: 10Ω ~ 1MΩ, Jumper (< 50mΩ) ±1%: 10Ω ~ 100KΩ
TCR (ppm/°C)	10Ω ~ 29.5Ω: ≤ ± 350 ppm/°C 30Ω ~ 1MΩ: ≤ ± 200 ppm/°C
Max. dissipation at T <sub>amb</sub> =70°C	1/32 W
Max. Operation Voltage (DC or RMS)	12.5V
Max. overload voltage	25V
Rated current for Jumper	1A
Operation temperature	-55 ~ +125°C

Note :

1. This is the maximum voltage that may be continuously supplied to the resistor element, see "IEC publication 60115-8"
2. Max. Operation Voltage : So called RCWV (Rated Continuous Working Voltage) is determined by

$$RCWV = \sqrt{\text{Rated Power} \times \text{Resistance Value}} \text{ or Max. RCWV listed above, whichever is lower.}$$

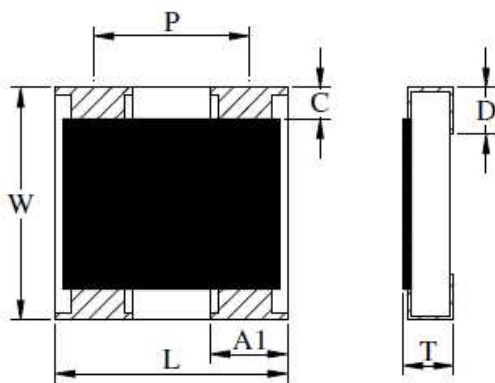
**DIMENSIONS(unit : mm)**

	WA02B
<b>L</b>	0.80 ± 0.10
<b>W</b>	0.60 ± 0.10
<b>T</b>	0.35 ± 0.10
<b>P</b>	0.50 typical
<b>A1</b>	0.30 ± 0.10
<b>C</b>	0.15 ± 0.10
<b>D</b>	0.15 ± 0.10

## MARKING

No marking for WA02B chip resistors array

## FUNCTIONAL DESCRIPTION

### Product characterization

Standard values of nominal resistance are taken from the E24 series for resistors with a tolerance of  $\pm 5\%$ ,  $\pm 1\%$ . The values of the E24 series are in accordance with "IEC publication 60063"

### Derating

The power that the resistor can dissipate depends on the operating temperature; see Fig.2

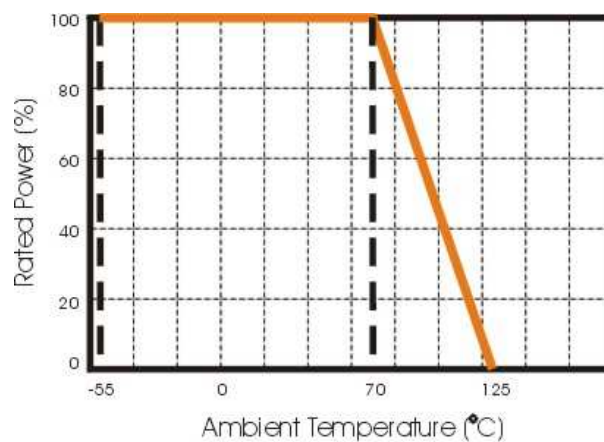
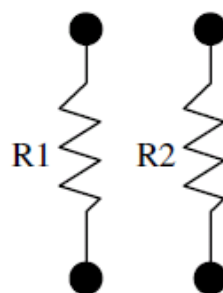

Figure 2. Maximum dissipation in percentage of rated power  
As a function of the ambient temperature

## CONSTRUCTION



$$R1=R2$$

## MOUNTING

Due to their rectangular shapes and small tolerances, Surface Mountable Resistors are suitable for handling by automatic placement systems.

Chip placement can be on ceramic substrates and printed-circuit boards (PCBs).

Electrical connection to the circuit is by individual soldering condition.

The end terminations guarantee a reliable contact.

### SOLDERING CONDITION

The robust construction of chip resistors allows them to be completely immersed in a solder bath of 260°C for 10 seconds. Therefore, it is possible to mount Surface Mount Resistors on one side of a PCB and other discrete components on the reverse (mixed PCBs).

Surface Mount Resistors are tested for solderability at 235°C during 2 seconds. The test condition for no leaching is 260°C for 30 seconds. Typical examples of soldering processes that provide reliable joints without any damage are given in Fig 3.

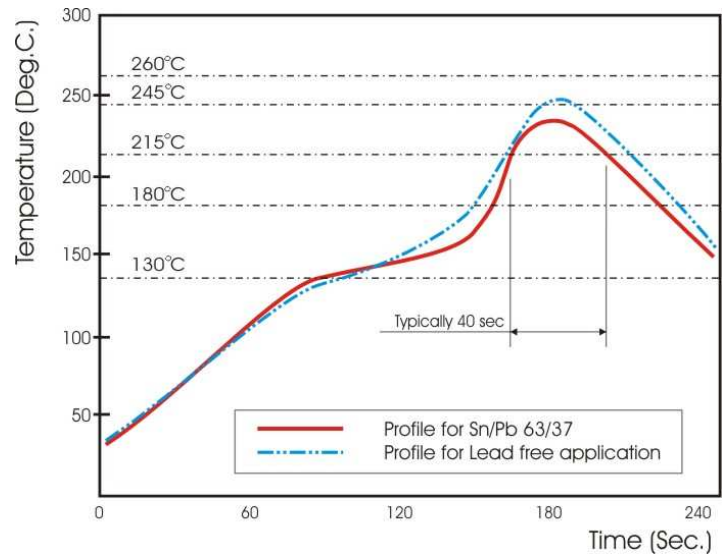

Fig 3. Infrared soldering profile for Chip Resistors array

### CATALOGUE NUMBERS

The resistors have a catalogue number starting with .

WA02	B	472_	J	T	L
<b>Size code</b> WA02 : 0201	<b>Type code</b> B : x2, Flat	<b>Resistance code</b> 5% E24 : 2 significant digits followed by no. of zeros and a blank 4.7Ω =4R7_ 10Ω =100_ 220Ω =221_ Jumper =000_ ("_" means a blank) 1%, E24+E96: 3 significant digits followed by no. of zeros 100Ω =1000 37.4KΩ =3742	<b>Tolerance</b> J : ±5% F : ±1% P : Jumper	<b>Packaging code</b> T : 7" 10kpcs Reel taping	<b>Termination code</b> L = Sn base (lead free)

Reeled tape packaging : 8mm width paper taping 7" reel 10,000pcs per reel,

### Recommended Land Pattern Dimensions:

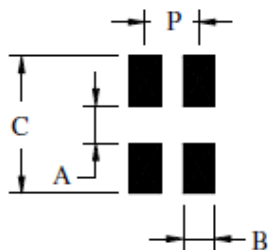

A	0.30
B	0.30
P	0.50
C	0.9

Unit : mm

## TEST AND REQUIREMENTS

Essentially all tests are carried out according to the schedule of IEC publication 115-8, category **LCT/UCT/56**(rated temperature range : **Lower Category Temperature, Upper Category Temperature**; damp heat, long term, 56 days). The testing also meets the requirements specified by EIA, EIAJ and JIS.

The tests are carried out in accordance with IEC publication 68, "Recommended basic climatic and mechanical robustness testing procedure for electronic components" and under standard atmospheric conditions according to IEC 60068-1, subclause 5.3. Unless otherwise specified, the following value supplied :

Temperature: 15°C to 35°C.

Relative humidity: 45% to 75%.

Air pressure: 86kPa to 106 kPa (860 mbar to 1060 mbar).

All soldering tests are performed with mildly activated flux.

TEST	PROCEDURE	REQUIREMENT	
		Resistor	Jumper
Electrical Characteristics <b>JISC5201-1: 1998</b> Clause 4.8	- DC resistance values measurement - Temperature Coefficient of Resistance (T.C.R) Natural resistance change per change in degree centigrade. $\frac{R_2 - R_1}{R_1(t_2 - t_1)} \times 10^6 \text{ (ppm/}^\circ\text{C)}$ $t_1 : 20^\circ\text{C}+5^\circ\text{C}-1^\circ\text{C}$  $R_1$ : Resistance at reference temperature $R_2$ : Resistance at test temperature	Within the specified tolerance Refer to "QUICK REFERENCE DATA"	N/a
Short time overload (S.T.O.L) <b>Clause 4.13</b>	Permanent resistance change after a 5 seconds application of a voltage 2.5 times RCWV or the maximum overload voltage specified in the above list, whichever is less.	$\Delta R/R$ max. $\pm(2\%+0.10\Omega)$	< 50m $\Omega$
Resistance to soldering heat(R.S.H) <b>Clause 4.18</b>	Un-mounted chips completely immersed for $10 \pm 1$ second in a SAC solder bath at $260^\circ\text{C} \pm 5^\circ\text{C}$	$\Delta R/R$ max. $\pm(1\%+0.05\Omega)$ no visible damage	< 50m $\Omega$
Solderability <b>Clause 4.17</b>	Un-mounted chips completely immersed for $2 \pm 0.5$ second in a SAC solder bath at $235^\circ\text{C} \pm 5^\circ\text{C}$	good tinning (>95% covered) no visible damage	
Temperature cycling <b>Clause 4.19</b>	30 minutes at $-55^\circ\text{C} \pm 3^\circ\text{C}$ , 2~3 minutes at $20^\circ\text{C}+5^\circ\text{C}-1^\circ\text{C}$ , 30 minutes at $+125^\circ\text{C} \pm 3^\circ\text{C}$ , 2~3 minutes at $20^\circ\text{C}+5^\circ\text{C}-1^\circ\text{C}$ , total 5 continuous cycles	$\Delta R/R$ max. $\pm(1\%+0.05\Omega)$ no visible damage	< 50m $\Omega$
Load life (endurance) <b>Clause 4.25</b>	1000 +48/-0 hours, loaded with RCWV or Vmax in chamber controller $70 \pm 2^\circ\text{C}$ , 1.5 hours on and 0.5 hours off	$\Delta R/R$ max. $\pm(3\%+0.1\Omega)$ no visible damage	< 100m $\Omega$
Load life in Humidity <b>Clause 4.24</b>	1000 +48/-0 hours, loaded with RCWV or Vmax in humidity chamber controller at $40^\circ\text{C} \pm 2^\circ\text{C}$ and 90~95% relative humidity, 1.5hours on and 0.5 hours off	$\Delta R/R$ max. $\pm(3\%+0.1\Omega)$ no visible damage	< 50m $\Omega$
Adhesion <b>Clause 4.32</b>	Pressurizing force: 5N, Test time: $10 \pm 1$ sec.	No remarkable damage or removal of the terminations.	
Insulation Resistance <b>Clause 4.6</b>	Apply the maximum overload voltage (DC) for 1minute	$R \geq 1\text{G}\Omega$	
Dielectric Withstand Voltage <b>Clause 4.7</b>	Apply the maximum overload voltage (AC) for 1 minute	No breakdown or flashover	

**PACKAGING**

Paper Tape specifications (unit: mm)

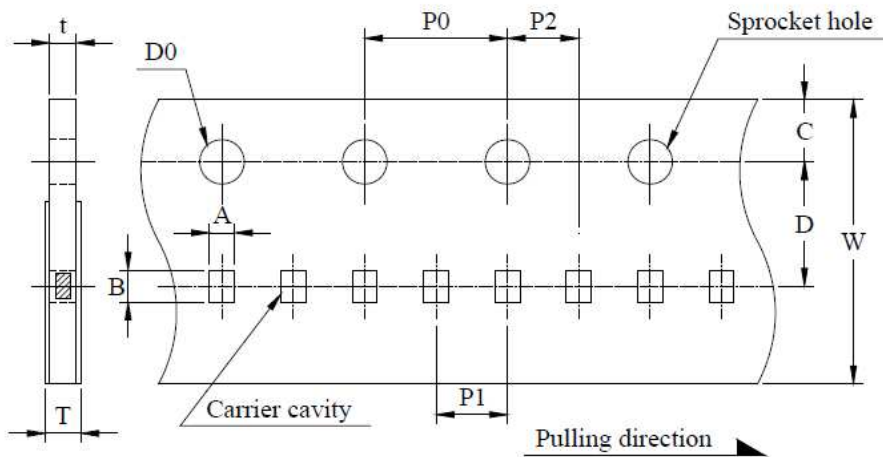

Code	Dimensions (mm)
A	0.70 ± 0.10
B	0.90 ± 0.10
W	8.0 ± 0.3
C	1.75 ± 0.1
D	3.5 ± 0.05
P0	4.0 ± 0.1
P1	2.0 ± 0.05
P2	2.0 ± 0.05
T	0.5 ± 0.1
t	0.43 ± 0.05
D0	$\phi 1.5_{-0.0}^{+0.1}$

**Reel dimensions**

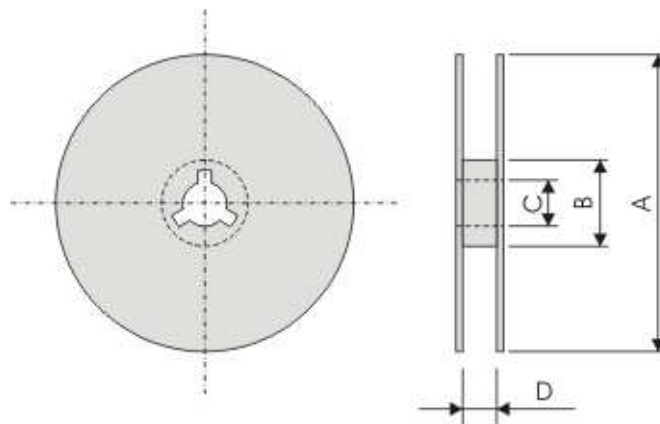

Symbol	A	B	C	D
(unit : mm)	$\Phi 178.0 \pm 2.0$	$\Phi 60.0 \pm 1.0$	$13.0 \pm 0.2$	$9.0 \pm 0.3$

**Peeling force of top cover tape**

The peel speed shall be about 300 mm/minute

The peel force of top cover tape shall be between 0.1 to 0.7 N

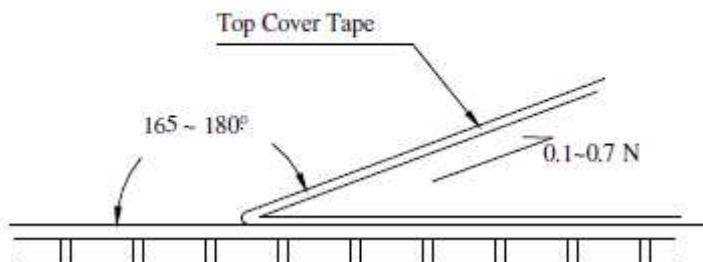

**Taping Qty**

10,000pieces per 7" reel