

# APPROVAL SHEET

**WT04X**

**±5%, Convex Type**

10p8R Chip resistors network

Size 1206

\*Contents in this sheet are subject to change without prior notice.

## FEATURE

1. Small size and light weight
2. Reduced size of final equipment
3. Lower surface mounted assembly costs
4. Higher component and equipment reliability
5. RoHS compliant and Lead free products

## APPLICATION

- Consumer electrical equipment
- EDP, Computer application

## DESCRIPTION

The resistors array is constructed in a high grade ceramic body (aluminum oxide). Internal metal electrodes are added at each end and connected by a resistive paste that is applied to the top surface of the substrate. The composition of the paste is adjusted to give the approximate resistance required and the value is trimmed to within tolerance by laser cutting of this resistive layer.

The resistive layer is covered with a protective coat. Finally, the two external end terminations are added. For ease of soldering the outer layer of these end terminations is Tin (Pb free) alloy.

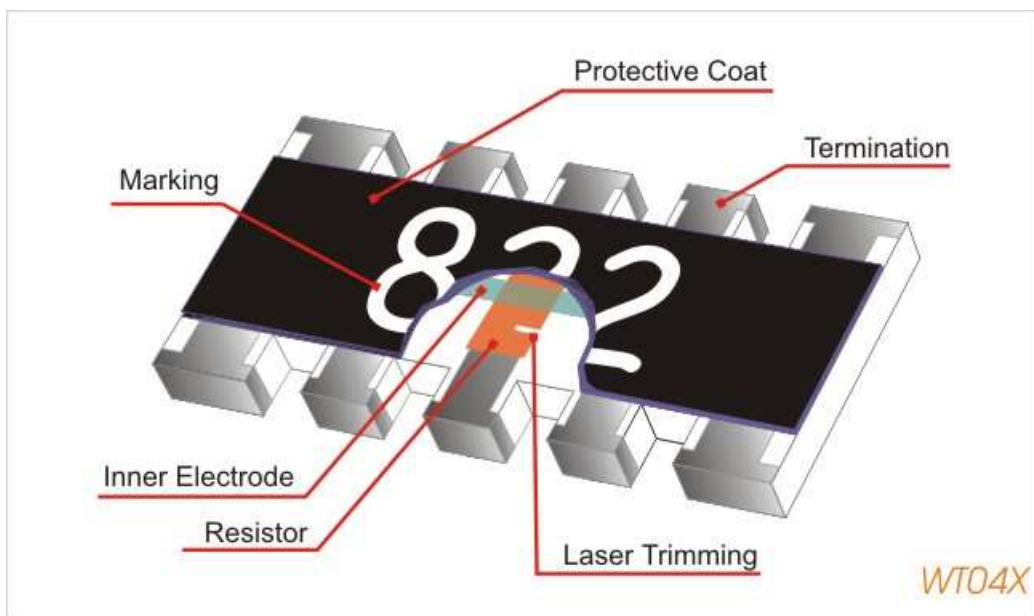

Fig 1. Construction of a Chip-R network WT04X

**QUICK REFERENCE DATA**

Item	General Specification
Series No.	WT04X(Convex type)
Size	1206 (3216)
Resistance Tolerance	±5% (E24 series)
Resistance Range	10Ω ~ 100KΩ
TCR (ppm/°C)	≤ ± 200 ppm/°C
Max. dissipation at T <sub>amb</sub> =70°C	1/16 W
Max. Operation Voltage (DC or RMS)	25V
Max. overload voltage	50V
Climatic category	55/155/56

Note :

1. This is the maximum voltage that may be continuously supplied to the resistor element, see "IEC publication 60115-8"
2. Max. Operation Voltage : So called RCWV (Rated Continuous Working Voltage) is determined by

$$RCWV = \sqrt{\text{Rated Power} \times \text{Resistance Value}} \text{ or Max. RCWV listed above, whichever is lower.}$$

**DIMENSIONS(unit : mm)**

	WT04X
<b>L</b>	3.30 ± 0.20
<b>W</b>	1.60 ± 0.15
<b>T</b>	0.55 ± 0.10
<b>P</b>	0.64 ± 0.05
<b>A</b>	0.50 ± 0.05
<b>B</b>	0.40 ± 0.15
<b>C</b>	0.40 ± 0.15
<b>G</b>	0.40 ± 0.15

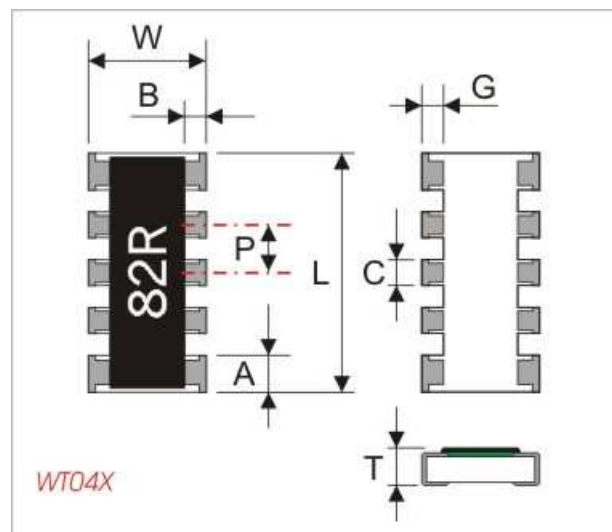

## MARKING

### 3-digits marking

Each resistor is marked with a three digits code on the protective coating to designate the nominal resistance value. For values up to 9.1 the R is used as a decimal point. For values of 10.0 or greater the first 2 digits apply to the resistance value and third indicate the number of zeros to follow.

### Example

<b>RESISTANCE</b>	10Ω	12Ω	100Ω	6800Ω	47000Ω
<b>3-digits marking</b>	100	120	101	682	473

## FUNCTIONAL DESCRIPTION

### Product characterization

Standard values of nominal resistance are taken from the E24 series for resistors with a tolerance of ±5%, The values of the E24 series are in accordance with “IEC publication 60063”

### Derating

The power that the resistor can dissipate depends on the operating temperature; see Fig.2

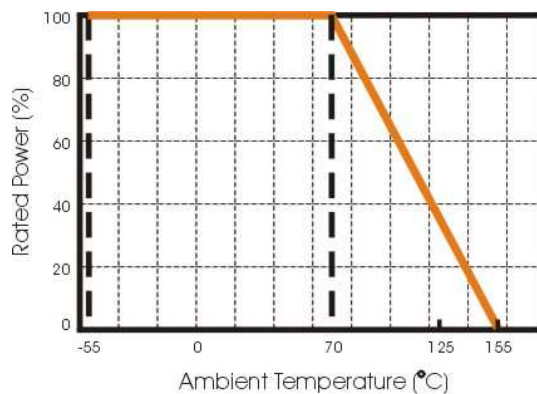
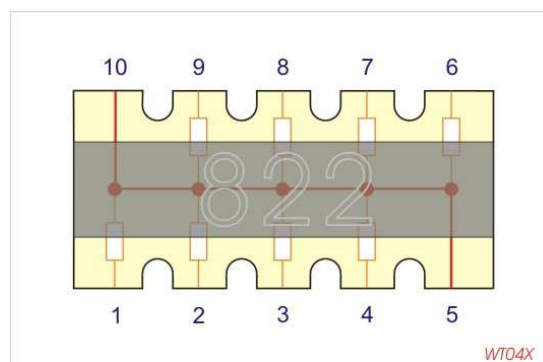

Figure 2. Maximum dissipation in percentage of rated power  
As a function of the ambient temperature

### Circuit Mode



$$R1=R2=R3=R4=R6=R7=R8=R9$$

### MOUNTING

Due to their rectangular shapes and small tolerances, Surface Mountable Resistors are suitable for handling by automatic placement systems.

Chip placement can be on ceramic substrates and printed-circuit boards (PCBs).

Electrical connection to the circuit is by individual soldering condition.

The end terminations guarantee a reliable contact.

### SOLDERING CONDITION

The robust construction of chip resistors allows them to be completely immersed in a solder bath of 260°C for 10 seconds. Therefore, it is possible to mount Surface Mount Resistors on one side of a PCB and other discrete components on the reverse (mixed PCBs).

Surface Mount Resistors are tested for solderability at 235°C during 2 seconds. The test condition for no leaching is 260°C for 30 seconds. Typical examples of soldering processes that provide reliable joints without any damage are given in Fig 3.

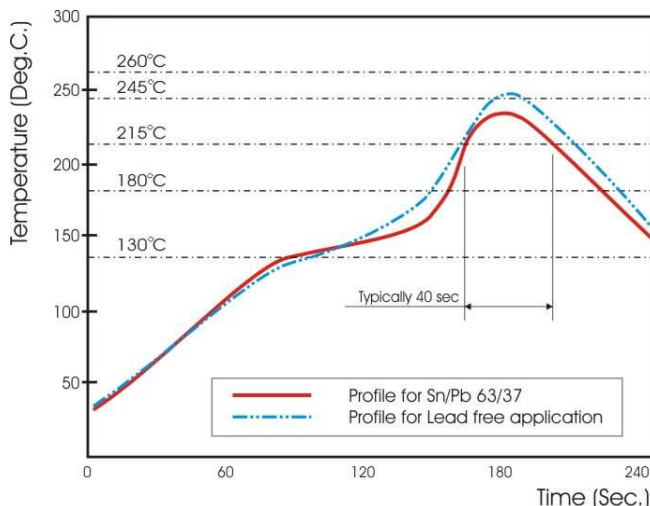

Fig 3. Infrared soldering profile for Chip Resistors network

### CATALOGUE NUMBERS

The resistors have a catalogue number starting with .

WT04	X	472_	J	T	L
<b>Size code</b> WT04 : 0402 per element	<b>Type code</b> X : 8 elements, convex terminations, common pin p5/p10	<b>Resistance code</b> E24 : 2 significant digits followed by no. of zeros and a blank 4.7Ω =4R7_ 10Ω =100_ 220Ω =221_ Jumper =000_ ("_" means a blank)	<b>Tolerance</b> J : ±5%	<b>Packaging code</b> T : 7" Reel taping	<b>Termination code</b> L = Sn base (lead free)

Reeled tape packaging : 8mm width paper taping 5000pcs per reel.

**TEST AND REQUIREMENTS(JIS C 5201-1 : 1998)**

TEST	PROCEDURE	REQUIREMENT
DC resistance <b>Clause 4.5</b>	DC resistance values measured at the test voltages specified below : <10Ω@0.1V, <100Ω@0.3V, <1KΩ@1.0V, <10KΩ@3V, <100KΩ@10V, <1MΩ@25V, <10MΩ@30V	Within the specified tolerance
Temperature Coefficient of Resistance(T.C.R) <b>Clause 4.8</b>	Natural resistance change per change in degree centigrade. $\frac{R_2 - R_1}{R_1(t_2 - t_1)} \times 10^6$ (ppm/°C) $t_1 : 20^\circ\text{C}+5^\circ\text{C}-1^\circ\text{C}$ $R_1$ : Resistance at reference temperature $R_2$ : Resistance at test temperature	Refer to "QUICK REFERENCE DATA"
Short time overload (S.T.O.L) <b>Clause 4.13</b>	Permanent resistance change after a 5second application of a voltage 2.5 times RCWV or the maximum overload voltage specified in the above list, whichever is less.	ΔR/R max. ±(2%+0.10Ω)
Resistance to soldering heat(R.S.H) <b>Clause 4.18</b>	Un-mounted chips completely immersed for 10±1second in a SAC solder bath at 260°C ±5°C	no visible damage Δ R/R max. ±(1.0%+0.05Ω)
Solderability <b>Clause 4.17</b>	Un-mounted chips completely immersed for 2±0.5 second in a SAC solder bath at 235°C ±5°C	good tinning (>95% covered) no visible damage
Temperature cycling <b>Clause 4.19</b>	30 minutes at -55°C±3°C, 2~3 minutes at 20°C+5°C-1°C, 30 minutes at +155°C±3°C, 2~3 minutes at 20°C+5°C-1°C, total 5 continuous cycles	no visible damage ΔR/R max. ±(1%+0.05Ω)
Load life (endurance) <b>Clause 4.25</b>	1000 +48/-0 hours, loaded with RCWV or Vmax in chamber controller 70±2°C, 1.5 hours on and 0.5 hours off	10Ω ~ 1MΩ : ΔR/R max. ±(3%+0.1Ω) R<10Ω, R≥1MΩ : ΔR/R max. ±(5%+0.1Ω)
Load life in Humidity <b>Clause 4.24</b>	1000 +48/-0 hours, loaded with RCWV or Vmax in humidity chamber controller at 40°C±2°C and 90~95% relative humidity, 1.5hours on and 0.5 hours off	10Ω ~ 1MΩ : ΔR/R max. ±(3%+0.1Ω) R<10Ω, R≥1MΩ : ΔR/R max. ±(5%+0.1Ω)
Adhesion <b>Clause 4.32</b>	Pressurizing force: 5N, Test time: 10±1sec.	No remarkable damage or removal of the terminations
Insulation Resistance <b>Clause 4.6</b>	Apply the maximum overload voltage (DC) for 1minute	R ≥ 10GΩ
Dielectric Withstand Voltage <b>Clause 4.7</b>	Apply the maximum overload voltage (AC) for 1 minute	No breakdown or flashover

**PACKAGING**

Paper Tape specifications (unit :mm)

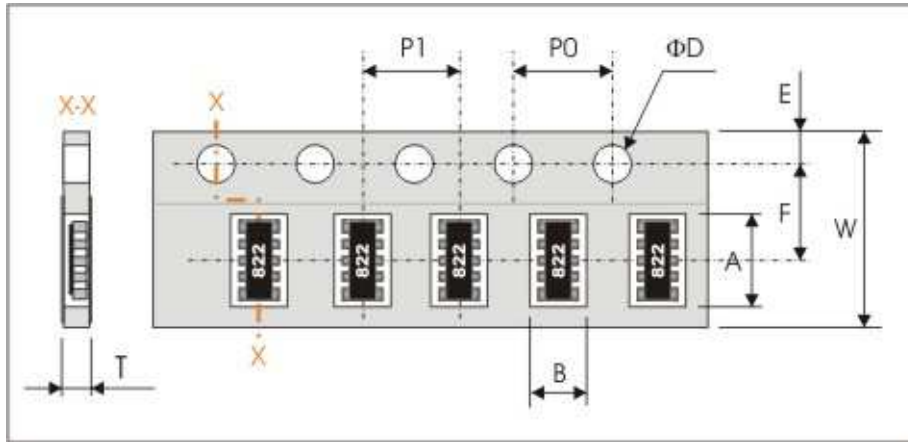

Series No.	A	B	W	F	E
WT04X	3.45 +0.20/-0	1.85 +0.20/-0	8.00±0.30	3.50±0.20	1.75±0.10
Series No.	P1	P0	ΦD	T	
WT04X	4.00±0.10	4.00±0.10	Φ1.50 <sup>+0.1</sup> <sub>-0.0</sub>	0.85±0.05	

**Reel dimensions**

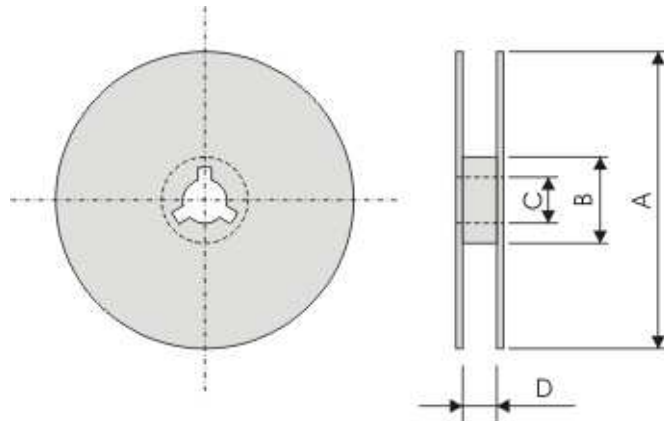

Symbol	A	B	C	D
(unit : mm)	Φ178.0±2.0	Φ60.0±1.0	13.0±0.2	9.0±0.5