

APPROVAL SHEET

WW12K

±1%, ±5%

Metal Ultra low ohm power chip resistors

Size 1206 1W

Metal Current Sensing Type

RoHS Compliant and Halogen free

Low EMF

Automotive AEC Q200 Compliant

*Contents in this sheet are subject to change without prior notice.

FEATURE

1. Ultra low and stable TCR performance
2. High power rating and low EMF $\pm 3\mu\text{V}/\text{degreeC}$
3. High reliability and stability
4. Reduced size of final equipment
5. RoHS compliant and Lead free product
6. Inductance below 1nH
7. Automotive AEC Q200 compliant

APPLICATION

- Power supply
- PDA
- Digital meter
- Computer
- Automotives
- Battery charger
- DC-DC power converter

DESCRIPTION

The resistors are constructed in a high grade low resistive metal body. The resistive layer is covered with a protective coat and printed a resistance marking code over it. Finally, the two external end terminations are added. For ease of soldering the outer layer of these end terminations is a lead-free solder.

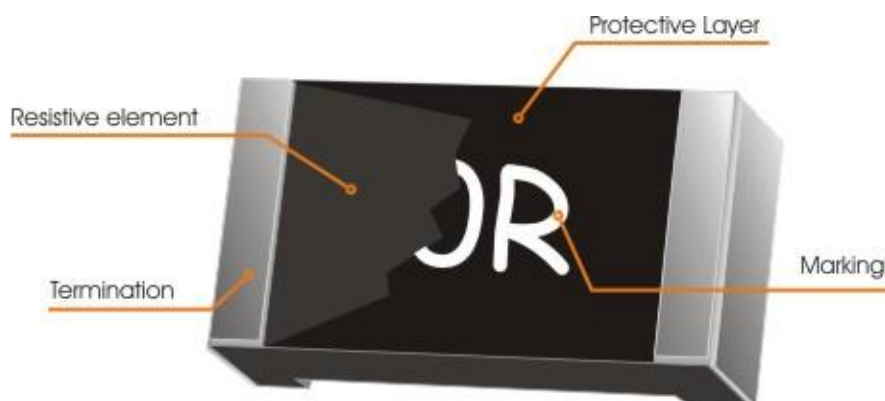

Fig 1. Construction of Chip-R

QUICK REFERENCE DATA

Item	Specification
Series No.	WW12K
Size code	1206 (3216)
Resistance Tolerance	±5%; ±1%
Resistance Value	0.003Ω, 0.004Ω, 0.005Ω, 0.006Ω, 0.010Ω, 0.015Ω, 0.020Ω, 0.025Ω,
TCR (ppm/°C)	±70
Max. dissipation at T _{amb} =70°C	1 W
Operation temperature	-55 ~ +170°C

Note :

1. This is the maximum voltage that may be continuously supplied to the resistor element, see "IEC publication 60115-8"
2. Max. Operation Voltage : So called RCWV (Rated Continuous Working Voltage) is determined by

$$RCWV = \sqrt{\text{Rated Power} \times \text{Resistance Value}} \text{ or Max. RCWV listed above, whichever is lower.}$$

MECHANICAL DATA

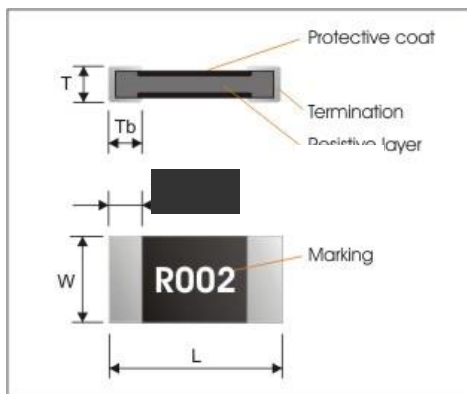

Symbol	WW12K
L	3.10±0.20
W	1.65±0.20
T	0.60±0.20
Tt	0.60±0.20
Tb	0.60±0.20

MARKING

1206* : R003/R004/R006

TOP : Laser marking product.

Bottom : Index sign.

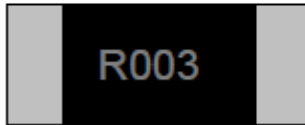

R003=3m Ω



TOP : Marking. (4 Digits marking to identify the resistance value.)

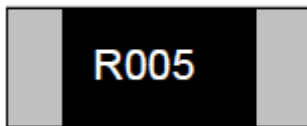

R005=5m Ω , R020=20m Ω

FUNCTIONAL DESCRIPTION

Derating curve

The power that the resistor can dissipate depends on the operating temperature; see Fig.2

Operating Temperature Range: -55 to +170 deg.C

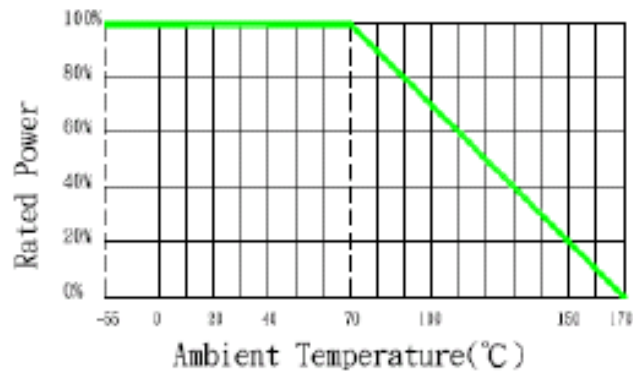

MOUNTING

Due to their rectangular shapes and small tolerances, Surface Mountable Resistors are suitable for handling by automatic placement systems.

Chip placement can be on ceramic substrates and printed-circuit boards (PCBs).

Electrical connection to the circuit is by individual soldering condition.

The end terminations guarantee a reliable contact.

SOLDERING CONDITION

The robust construction of chip resistors allows them to be completely immersed in a solder bath of 260°C for 10 seconds. Therefore, it is possible to mount Surface Mount Resistors on one side of a PCB and other discrete components on the reverse (mixed PCBs).

Surface Mount Resistors are tested for solderability at 235°C during 3 seconds. The test condition for no leaching is 260°C for 30 seconds. Typical examples of soldering processes that provide reliable joints without any damage are given in Fig 3.

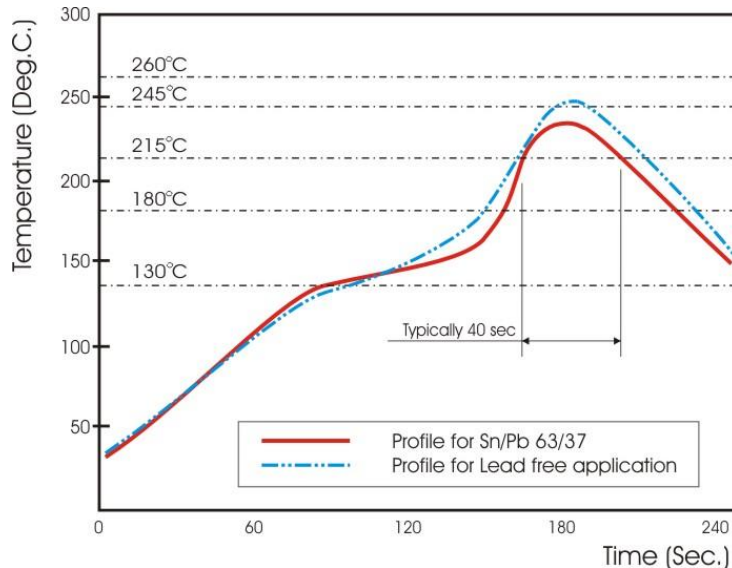

Fig 3. Infrared soldering profile for Chip Resistors WW12

CATALOGUE NUMBERS

The resistors have a catalogue number starting with

WW12	K	R010	F	T	L	J
Size code WW12 : 1206	Type code K : 1206 - 1W Metal strip Low EMF	Resistance code R is first digit followed by 3 significant digits. 0.010Ω = R010	Tolerance J : ±5% F : ±1%	Packaging code T : 7" reel in paper tape (1206 4Kpcs/RL)	Termination code L = Sn base (lead free)	Special code J = AEC Q200 compliant

WW12K: 4,000 pcs per Paper Tape reel

TEST AND REQUIREMENTS (AEC Q200)

TEST	PROCEDURE	REQUIREMENT
Temperature Coefficient of Resistance(T.C.R) Clause 4.8	Natural resistance change per change in degree centigrade. $\frac{R_2 - R_1}{R_1(t_2 - t_1)} \times 10^6 \text{ (ppm/}^\circ\text{C)}$ $t_1 : 20^\circ\text{C}+5^\circ\text{C}-1^\circ\text{C}$ R_1 : Resistance at reference temperature R_2 : Resistance at test temperature	Refer to "QUICK REFERENCE DATA"
High Temperature Exposure (Storage) MIL-STD-202 Method 108	Test 1000 hrs./ @T=125°C/ Un-powered. Measurement at 24±2 hours after test conclusion.	ΔR/R max. ±(1%+0.5mΩ) no visible damage
Temperature cycling JESD22 Method JA-104	Test 1000 cycles (-55°C to +125°C). Measurement at 24±2 hours after test conclusion	no visible damage ΔR/R max. ±(0.5%+0.5mΩ)
Moisture Resistance MIL-STD-202 Method 106	Test 65°C/ 80~100%RH/ 10Cycles(t=24hrs/cycle). Measurement at 24±2 hours after test conclusion.	no visible damage ΔR/R max. ±(0.5%+0.5mΩ)
Bias Humidity MIL-STD-202 Method 103	Test 1000 hours/ @85°C/85% RH./ 10% of operation power. Measurement at 24±2 hours after test conclusion.	no visible damage ΔR/R max. ±(1%+0.5mΩ)
Operation life MIL-STD-202 Method 108	Test 1000 hrs./ TA=125°C / 35% of operating power. Measurement at 24±2 hours after test conclusion	no visible damage ΔR/R max. ±(1%+0.5mΩ)
External Visual MIL-STD-883 Method 2009	Inspect device construction, marking and workmanship	no visible damage
Physical Dimensions JESD22 Method JB-100	The chip dimension (L, W, T, D) prescribed in the detail specification shall be checked by Protech 2.5D.	Within the specified tolerance
Mechanical Shock MIL-STD-202 Method 213	Test Peak value:100g's / Wave:Hail-sine / Duration:6ms / Velocity:12.3ft/sec.	Within product specification tolerance and no visible damage
Vibration MIL-STD-202 Method 204	Test 5g's for 20min., 12 cycles each of 3 orientations.	no visible damage ΔR/R max. ±(0.5%+0.5mΩ)
Resistance to soldering heat (R.S.H) MIL-STD-202 Method 210	Solder dipping @ 270°C ±5°C for 10sec.±1sec.	no visible damage ΔR/R max. ±(0.5%+0.5mΩ)
Thermal Shock MIL-STD-202 Method 107	Test -55 to 155°C / dwell time 15min/ Max transfer time 20sec/ 300cycles.	no visible damage ΔR/R max. ±(0.5%+0.5mΩ)
ESD AEC-Q200-002	Test contact 1KV (Min)	no visible damage ΔR/R max. ±(1%+0.5mΩ)
Solderability J-STD-002	a) Bake the sample for 155°C dwell time 4hrs/ solder dipping 235°C/ 5sec. b) Steam the sample dwell time 8 hour/ solder dipping 215°C/ 5sec. c) Steam the sample dwell time 8 hour/ solder dipping 260°C/ 7sec.	good tinning (>95% covered) no visible damage
Board Flex AEC-Q200-005	Bending 2mm	no visible damage ΔR/R max. ±(0.5%+0.5mΩ)
Terminal Strength AEC-Q200-006	Force: 1.8kg for 60sec.	No cracking or no part being sheared off from its pad.

PACKAGING

Paper Tape specifications (unit :mm)

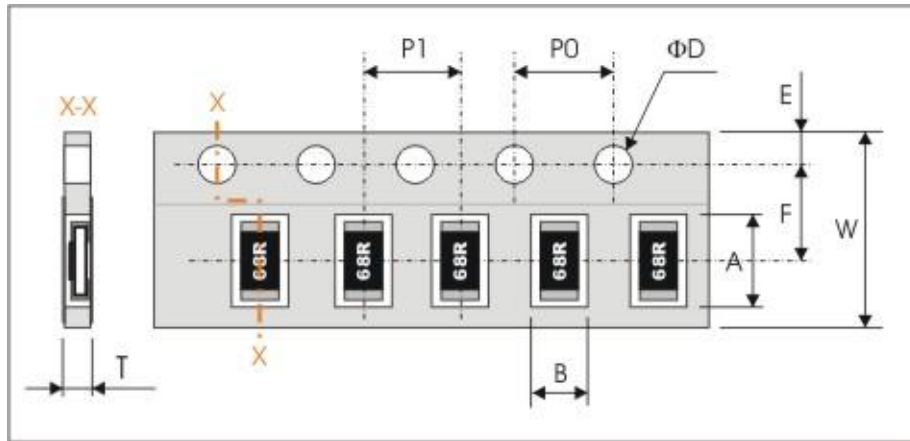

Series No.	A	B	W	F	E
WW12K	3.60±0.20	2.00±0.20	8.00±0.30	3.50±0.05	1.75±0.10

Series No.	P1	P0	ΦD
WW12K	4.00±0.10	4.00±0.10	Φ1.50 ^{+0.1} _{-0.0}

Reel dimensions

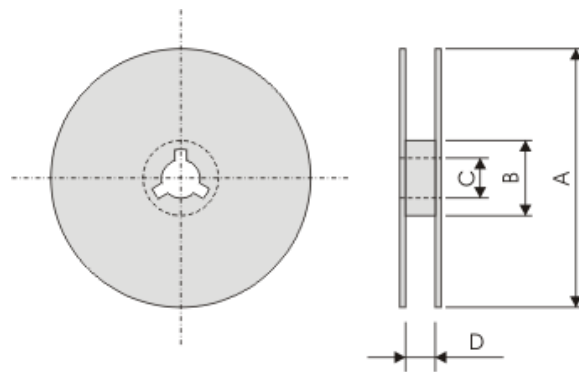

Size	A	B	C	D
1206	Φ178.0±2.0	Φ60.0±1.0	13.0±0.5	10.0±1.5

Taping Qty: 1206: 4,000pcs per reel;