

APPROVAL SHEET

WLPM706630M150LP
WLPM706630M220LP
SMD Molding Power Inductor



*Contents in this sheet are subject to change without prior notice.

Features

1. Shielded construction.
2. Ultra low buzz noise.
3. Low DCR/ μ H.
4. Handles high transient current spikes without saturation.
5. Encapsulated body offers improved environmental protection and moisture resistance.
6. Higher dielectric withstanding voltage.
7. Corrosion resistant package.
8. RoHS Compliance.

Applications

1. PDA/Notebook/Desktop/Server applications high current and low profile power supplier
2. High current POL converters.
3. Battery powered devices.

Shape and Dimension

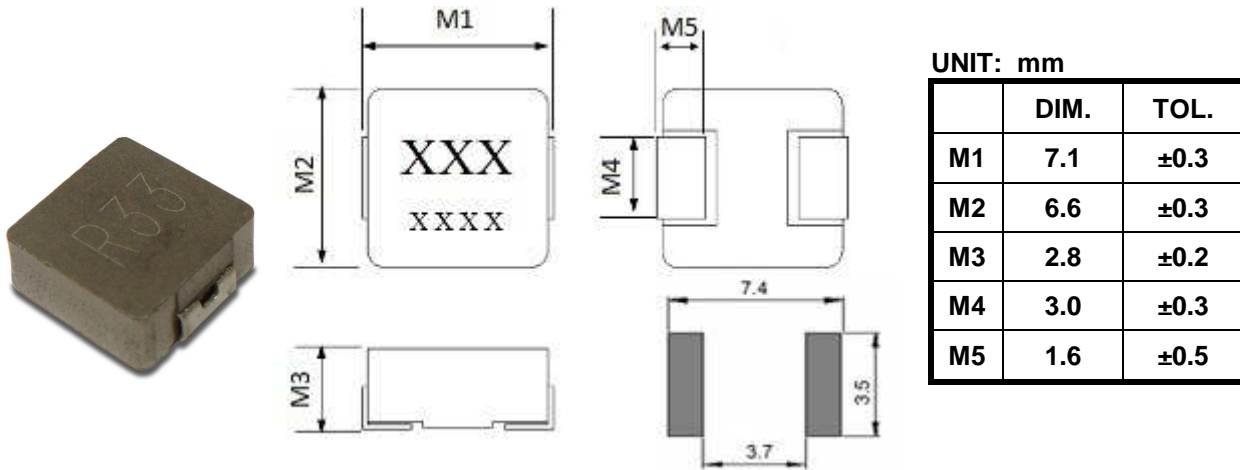

MARKING AND DATE CODE

Marking ex:1.0uH \rightarrow 1R0

Date code

XX XX \rightarrow year and weekly ex:1033

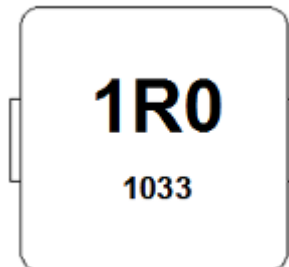

Ordering Information

WL	PM	7066	30	M	100	L	P
Product Code WL: Inductor	Series SMD Molded power inductor.	Dimensions 7.1 * 6.6mm	Thickness 2.8mm	Tolerance M: ± 20%	Value R22=0.22uH 1R0=1.0uH 100=10uH	Packing Code L=13" Reeled (Embossed tape)	Internal code

Electrical Characteristics

Walsin Part Number	L(uH)	Tolerance	Measuring Frequency (kHz),1V	RDC Maximum (mΩ)		Rated Current Typical (A)	I sat Typical (A)
				TYP.	MAX.		
WLPM706630M150LP	15	M	100	110	125	3.5	3
WLPM706630M220LP	22	M	100	180	200	2.3	3

TEST INSTRUMENT:

Inductance: WK3260B,HP4284A,CH3302; DC Resistance: CH16502 Micro-Ohm Meter;
Idc & I sat: WK3260B/WK3265B(BIAS)

NOTE:

1. Test Freq.: 100KHz, 1.0V
2. All test data is referenced to 25°C ambient.
3. Operating Temperature Range -55°C~+125°C.
4. Storage Temperature Range: 25°C~35°C, <70% R.H.
5. Idc: DC current (A) that will cause an approximate ΔT of 40°C.
6. I sat: DC current (A) that will cause Lo to drop approximately 30%.
7. The Part temperature should not exceed 125°C under worst case operating condition.
Part temperature should be checked and verified by the application developer(s) as the performance of the part might be affected.
8. MSL: Level 1

Electrical Curve

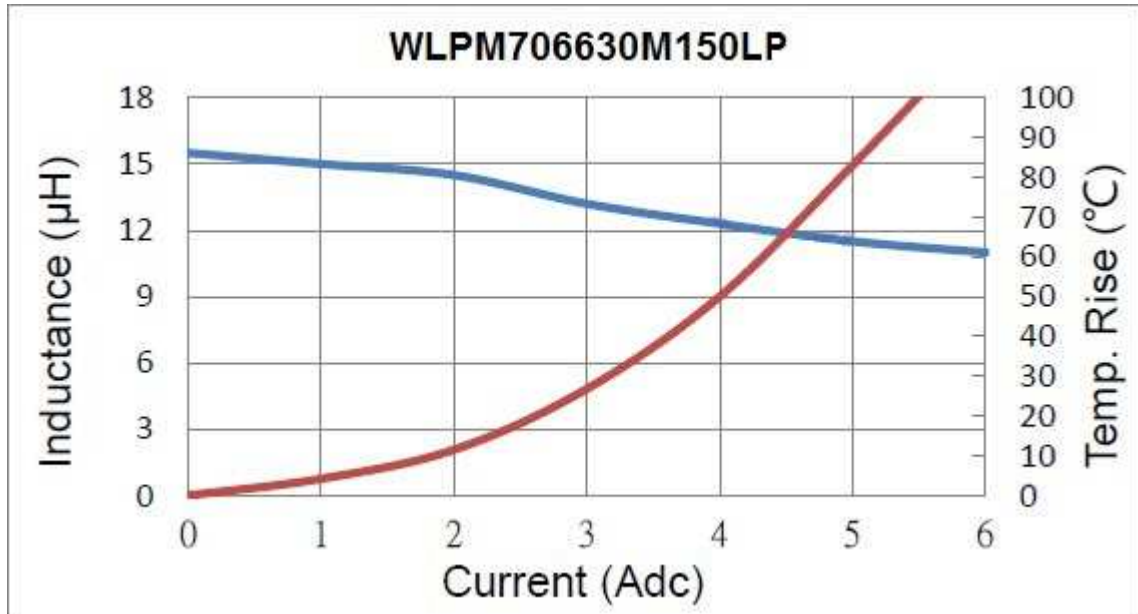

RELIABILITY PERFORMANCE

Reliability Experiment For Electrical

Test Item	Accept criteria	Test Condition	Standard Source
Humidity Test	1.Change from an initial value L:within±5% 2.no visible damage.	+40°C± 2°C, humidity of 90% ±5% (total 96 hours).	MIL-STD-202G Method 103B Test Condition B
High Temperature Test	1.Change from an initial value L:within±5% 2.no visible damage.	1.Temperature: +125°C±2°C. 2.Test time: 48±2hrs.	IEC 68-2 Test Condition B
Low Temperature Test	1.Change from an initial value L:within±5% 2.no visible damage.	1.Temperature: -25°C±2°C. 2.Test time: 48±2hrs.	IEC 68-2 Test Condition A
Thermal Shock	1.Change from an initial value L:within±5% 2.no visible damage.	+125°C±5°C (30 minutes) ~ -55±5°C (30 minutes), temperature switch time: 5 minutes (total 50 cycles) Wind speeds 10m/sec.	Reference MIL-STD-202G Method 107G Test Condition A-2
Life Test	1.Change from an initial value L:within±5% 2.no visible damage.	+70°C±5°C (250Hours).	Reference MIL-STD-202G Method 108A Test Condition B

Reliability Experiment For Physical

Test Item	Accept criteria	Test Condition	Standard Source
Vibration Test	1.Change from an initial value L:within±5% 2.no visible damage.	10-55-10HZ, amplitude: 1.5mm, direction: X, Y, Z axes, each axis 2 hours (total 6 hours).	MIL-STD-202G Method 201A
Solder Heat Resistance Test	1.no visible damage.	IR/convection reflow: Peak Temp 255°C~260°C for 3~5 Sec. in air, Through 2 Cycle. Temperature Ramp:+1~4°C/sec.; Above 217°C, must keep 90 s - 120 s.	Reference MIL-STD-202G Method 210F Test Condition K (Reflow)
Solder Ability Test	1. Lead must have 95% above coverage.	Soak in 245°C solder pot of 3~5 Sec.	Reference J-STD-002D

TYPICAL RoHS REFLOW PROFILE

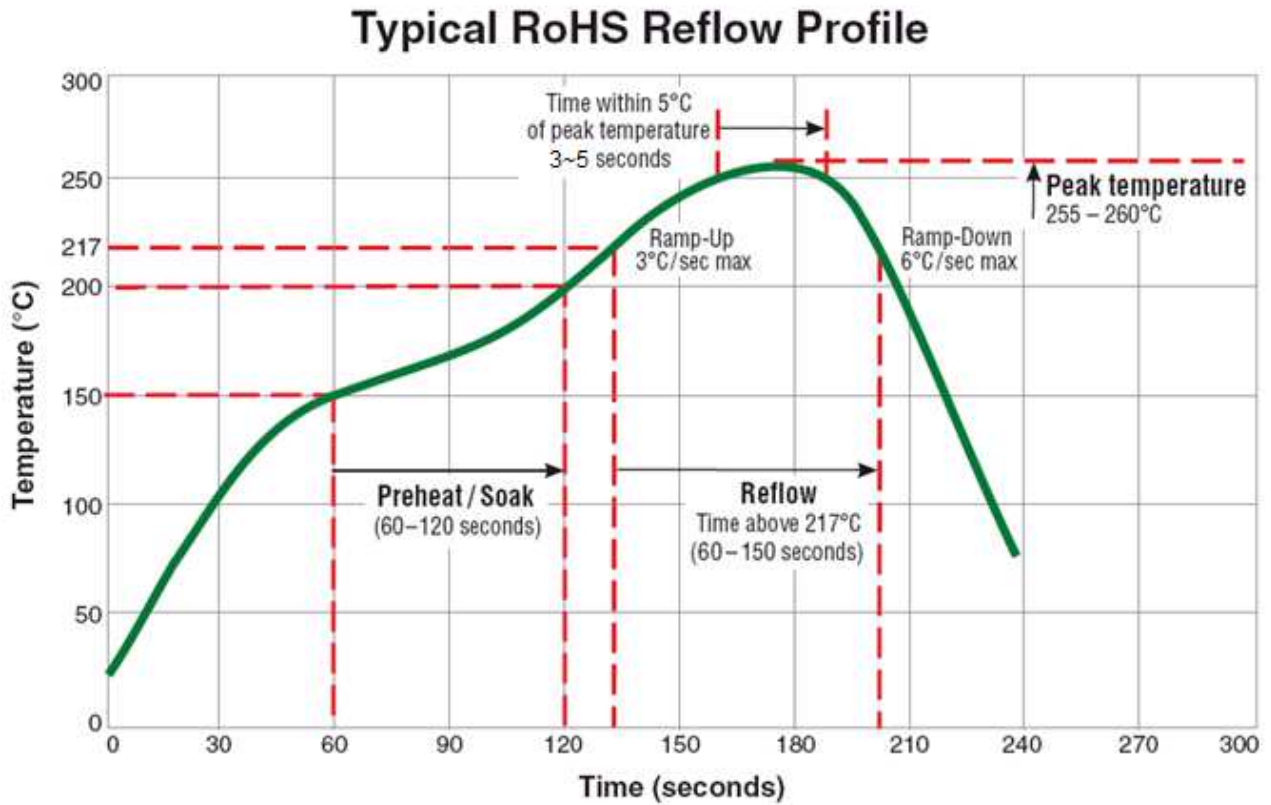

Packaging

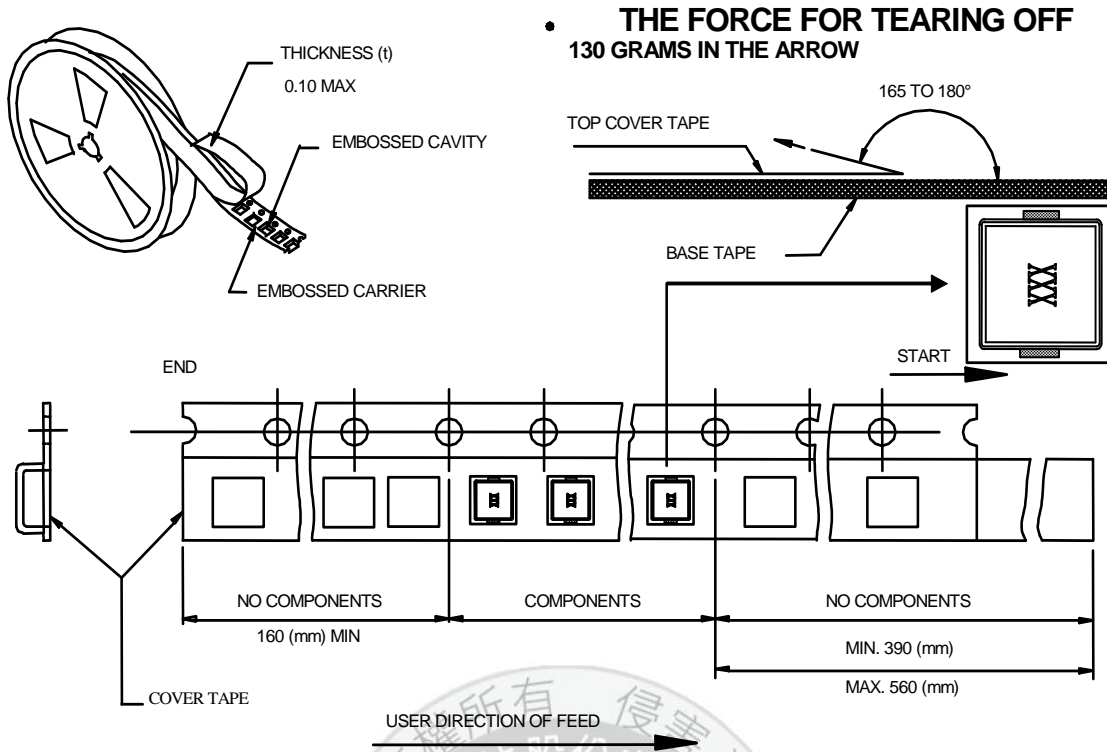

CARRIER TAPE REELS (mm)

MATERIAL: PLASTIC

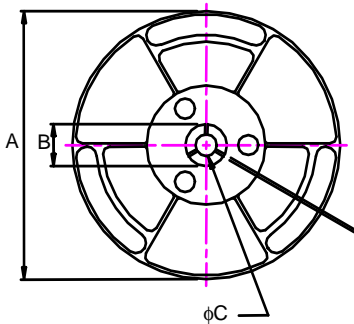

DIMENSIONS OF CARRIER TAPE (mm)

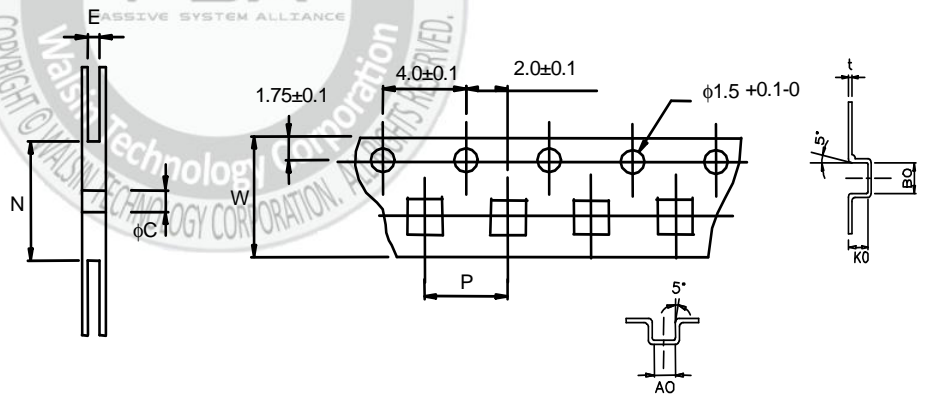

※ 10 sprocket hole pitch cumulative tolerance ±0.20

UNIT : mm

	A	B	C	E	N	P	W	t	A0	B0	K0
DIM.	330	25.0	13.0	16.6	100	12.0	16.0	0.4	6.9	7.6	3.4
TOL.	±0.2	±0.5	±0.5	±0.5	MIN	±0.1	±0.3	±0.05	±0.1	±0.1	±0.1

Quantity Per Reel : 1K pcs