



**PSA** PASSIVE SYSTEM ALLIANCE  
WALSIN TECHNOLOGY CORPORATION

## Chip Resistors

[www.passivecomponent.com](http://www.passivecomponent.com)



## Product Portfolio



Multilayer Ceramic Capacitors



Chip Resistors

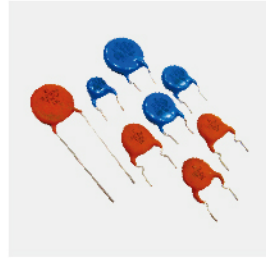

Disc Capacitors

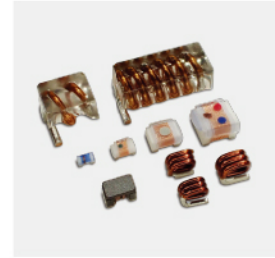

Inductors



RF Filters



Antenna

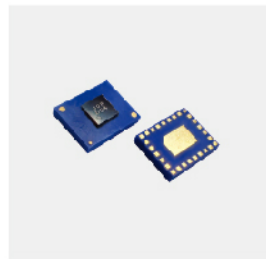

Antenna Switch & Module



MOV & MLV

## IEC-63 Nominal Resistance / Capacitance

<b>E1</b>	100																							
<b>E3</b>	100			220			470																	
<b>E6</b>	100	150	220	330	470	680																		
<b>E12</b>	100	120	150	180	220	270	330	390	470	560	680	820												
<b>E24</b>	100	110	120	130	150	160	180	200	220	240	270	300	330	360	390	430	470	510	560	620	680	750	820	910
<b>E96</b>	100	102	121	124	147	150	178	182	215	221	261	267	316	324	383	392	464	475	562	576	681	698	825	845
	105	107	127	130	154	158	187	191	226	232	274	280	332	340	402	412	487	499	590	604	715	732	866	887
	110	113	133	137	162	165	196	200	237	243	287	294	348	357	422	432	511	523	619	634	750	768	909	931
	115	118	140	143	169	174	205	210	249	255	301	309	365	374	442	453	536	549	649	665	787	806	953	976

E6:  $\sqrt[6]{10} \approx 1.46$  E12:  $\sqrt[12]{10} \approx 1.21$

E1 series resistance: 1Ω, 10Ω, 100Ω, 1000Ω, 10000Ω, 100000Ω

INDEX

<b>Subject</b>	<b>Page</b>
How to Order .....	1
Chip Resistors Selection Guide .....	3
General Purpose Chip Resistors (1Ω~10MΩ) .....	11
Thick Film Low Ohm and Power Low Ohm Chip Resistors .....	12
Metal Low Ohm Current Sensing Chip Resistors (0.001Ω ~ 0.100Ω) .....	13
Chip Resistor Array: Convex Termination .....	14
WA06W Chip Resistor Array 16P8R .....	15
Chip Resistor Array: Concave Termination .....	16
High Precision Thin Film Chip Resistor Array: Convex Termination .....	17
WT04X Chip Resistor Network 10P8R .....	18
WA04P Chip Attenuator .....	19
Special Chip Resistor .....	20
MR/SR Series of Automotive & Anti-Sulfuration Chip Resistor .....	20
WR_R Series of Total Lead Free Chip Resistor .....	20
WKxxM Series of Trimmable Chip Resistor .....	21
WKxxV Series of High Voltage Chip Resistor .....	21
WFxxP/WFxxA Series of High Power Chip Resistor .....	22
WKxxS Series of Anti-Surge Chip Resistor .....	23
Thick Film High Precision Chip Resistor .....	23
Thin Film Precision Chip Resistor: WF Series .....	24
High Precision Thin Film Chip Resistor (AEC-Q200): WF_Q Series .....	25
Thin Film Anti-Sulfuration Chip Resistor: SF Series .....	26
Thin Film Anti-Sulfuration (ASTM-B809 & under Oil 105°C+3.5% Sulfur power 500 hours): SF_A Serie .....	26
Thin Film Anti-Sulfuration Chip Resistor (AEC-Q200/ASTM-B809): SF_Q Series .....	27
TaN Thin Film Chip Resistor (AutoGrade/AEC-Q200/ASTM B-809): MF Series .....	28
Thin Film Low ohmic Current Sensor: WW Series .....	28
Thin Film Foil Current Sensor (Low TCR/Tight Tolerance): TTL Series .....	29
MELF Thin Film Resistor: WM Series (AEC-Q200) .....	30
Test and Requirements .....	31
Packing on Tape and Reel .....	36
Footprint Design .....	37
Storage and Handling Condition .....	38
Recommendation of Soldering Profiles .....	38

\*The specifications are subject to change or our products in it may be discontinued without advance notice. Please check with our sales representatives or product engineers before ordering.

\*This catalog has only typical specifications because there is no space for detailed specifications. Therefore, please approve our product specifications or transact the approval sheet for product specifications before ordering.

■ **HOW TO ORDER**

Type code	Size code	Functional code	Resistance	Tolerance	Packaging code	Termination code
<b>WR</b>	<b>12</b>	<b>X</b>	<b>1000</b>	<b>F</b>	<b>T</b>	<b>L</b>
WR : General 1~10MR MR : Automotive SR : Anti-Sulfuration ZR : Non magnetic	25 : 2512 (6432) 20 : 2010 (5025) 18 : 1218 (3248) 12 : 1206 (3216) 10 : 1210 (3225) 08 : 0805 (2012) 06 : 0603 (1608) 04 : 0402 (1005) 02 : 0201 (0603) 01 : 01005 (0402)	X : 5% for 1 ~ 10MΩ, 1% for 10 ~ 1MΩ W : 1% for <10Ω and >1MΩ F : TC100, 1-10ohm 1% E : TC100, 100-1Mohm 5%	E24 (J tol.) E24+E96 (F tol.)  *Please see remark for detail explanation	F : ± 1% J : ± 5% P : Jumper X : random	P : 4" reel taping T : 7" reel taping A : 7" reel taping 15Kpcs D : 7" reel taping 20Kpcs E : 7" up side down taping V : 7" reel taping 1Kpcs Q : 10" reel taping G : 13" reel taping H : 0402-50K/13" reel R : 0603 2mm pitch 7" reel B : Bulk C : Bulk after measuring F : 0402 1mm pitch (30K/ 7" reel) K : 10" reel taping (0402 30K/RL) J : 10" reel taping (0402 40K/RL) I : 13" up side down taping L : 01005 1mm pitch (35K/7" RL)	L= Sn base (Lead free) R= Pb ≤100ppm (total) W= Wide term. A= Anti-leaching P= 20% Pd
<b>WW</b>	<b>12</b>	<b>M</b>	<b>R002</b>	<b>F</b>	<b>T</b>	<b>L</b>
WW : R < 1Ω	25 : 2512 (6432) 20 : 2010 (5025) 18 : 1218 (3248) 12 : 1206 (3216) 10 : 1210 (3225) 08 : 0805 (2012) 06 : 0603 (1608) 04 : 0402 (1005)	X : Thick film low ohm (WTC) W : Thick film low TCR Hi-power Q : Metal low ohm M : Metal low ohm R : Metal low ohm high power N : Metal low ohm high power P : Thick film low TCR high Power 2512 = 2W; 2010 = 1W 1210 = 0.5W; 1206 = 0.5W C : Thick film Power low ohm low TCR, up side down D : Metal Foil E : Thick film Power low ohm A : Metal low ohm NiCu 2512 3W B : Metal low ohm MnCu 2512 3W J : Metal low ohm low EMF K : Metal low ohm low EMF L : Thick film wide term. High power T : Thick film triple power WW25T 3W	R followed by 3 significant digits e.g. :  0.1Ω = R100 0.033Ω = R033 0.56Ω = R560 0.5mΩ = R0L5 15.5mΩ = 15L5	F : ± 1% G : ± 2% J : ± 5%	P : 4" reel taping T : 7" reel taping Q : 7" reel taping G : 13" reel taping R : 0603 2mm pitch taping B : Bulk U : 7" reel taping ( 4kpcs/RL ) Z : 7" reel taping ( 3kpcs/RL )	L= Sn base (Lead free)  G= Au base  S= Ag base
<b>WF/WK</b>	<b>12</b>	<b>T</b>	<b>1001</b>	<b>B</b>	<b>T</b>	<b>L</b>
WF: Special Function SF: Special Function Anti-Sulfur WK: Special function Made in KM	25 : 2512 (6432) 20 : 2010 (5025) 18 : 1218 (3248) 12 : 1206 (3216) 10 : 1210 (3225) 08 : 0805 (2012) 06 : 0603 (1608) 04 : 0402 (1005)	G : High ohm (>10MΩ) H : Thick film, High Precision <1% K : Thick film, TCR50ppm M : Trimmable P : High Power S : Surge V : High voltage N : Ultra High voltage ( WFxxN for UL) X : Special resistance Y : E24/E96 resistance with special Termination A : Triple Power 2512 3W E : Triple power + Surge	E24 (J tol.) E24+E96 (F tol.)  *Please see remark for detail explanation	T : ± 0.01% U : ± 0.02% A : ± 0.05% B : ± 0.1% C : ± 0.25% D : ± 0.5% F : ± 1% G : ± 2% J : ± 5% K : ± 10% L : ± 15% M : ± 20% P : Jumper X : 0/-30% Y : 0/-20% Z : 0/-10%	P : 4" reel taping T : 7" reel taping Q : 10" reel taping M : 10" reel taping 4Kpc/RL G : 13" reel taping R : 0603 2mm pitch taping B : Bulk D : 7" reel taping 20Kpcs V : 7" reel taping 1Kpcs A : 7" reel taping 15Kpcs W : 7" reel taping 2Kpcs Z : 7" reel taping ( 3kpcs/RL )	L= Sn base (Lead free)  G= Au base  S= Ag base  C= Cu base  D= Cu base + Low profile  N= Narrow termination
<b>WA</b>	<b>04</b>	<b>X</b>	<b>103_</b>	<b>J</b>	<b>T</b>	<b>L</b>
WA : Array MA : Array Automotive SA : Array Anti-Sulfur TA : Thin Film Array Convex	06 : 0603 (1608) 04 : 0402 (1005) 02 : 0201 (0603)	X : *4, convex Y : *2, convex W : *8, convex T : *4, concave U : *2, concave P : *3, convex (Attenuator) A : *4, FLAT B : *2, FLAT F : *4, Reverse FLAT G : *2, Reverse FLAT	E24 (J tol.) E24+E96 (F tol.)  **Please see remark for detail explanation	F : ± 1% J : ± 5% P : Jumper B : ± 0.1% C : ± 0.25% D : ± 0.5%	T : 7" reel taping A : 7" reel taping 15Kpcs Q : 10" reel taping G : 13" reel taping B : Bulk	L= Sn base (Lead free)
<b>WT</b>	<b>04</b>	<b>X</b>	<b>103_</b>	<b>J</b>	<b>T</b>	<b>L</b>
T : Network Resistors	04 : total package size 1206 (3216)	X : *8, convex	E24 (J tol.)	J : ± 5% P : Jumper	T : 7" reel taping B : Bulk	L= Sn base (Lead free)

■ HOW TO ORDER

Thin Film Series: Precision; High Precision; Auto Grade; MELF ; Current Sensing Resistor

Type code	Size code	Functional code	Resistance	Tolerance	Packaging code	Termination code	Special code
<b>WF/SF/MF</b>	<b>12</b>	<b>T</b>	<b>1001</b>	<b>B</b>	<b>T</b>	<b>L</b>	<b>Q</b>
WF: Thin Film Precision SF: Thin Film Anti-Sulfuration WF_Q: High Precision Thin Film AEC-Q200 Compliant SF_Q: Thin Film Anti-Sulfuration/ AEC-Q200 Compliant ASTM B809 SF_A: High Precision Thin Film Anti-Sulfuration ASTM B809 +Under Oil 105°C+3.5% Sulfur power 500hrs MF: Precision Thin Film Auto Grade AEC-Q200 Qualified ASTM-B809	25 : 2512 (6432) 20 : 2010 (5025) 12 : 1206 (3216) 10 : 1210 (3225) 08 : 0805 (2012) 06 : 0603 (1608) 04 : 0402 (1005) 02 : 0201 (0603)	T : TCR 50 ppm U : TCR 25 ppm Q : TCR 50 ppm, Power R : TCR 25 ppm, Power F : Low TCR 15 ppm W : Low TCR 10 ppm Z : Ultra Low TCR 5 ppm B : Ultra Low TCR 3 ppm C : Ultra Low TCR 2 ppm D : Ultra Low TCR 1 ppm *  * Available Upon Request	E24+E192  **Please see remark for detail explanation	T : ± 0.01% U : ± 0.02% A : ± 0.05% B : ± 0.1% C : ± 0.25% D : ± 0.5% F : ± 1%	T : 7" Reel & Taped Q : 10" Reel & Taped G : 13" Reel & Taped V : 7" Reel & Taped 1Kpcs B : Bulk	L= Sn base (Lead free)	Q= AEC-Q200 Compliant  A= Under Oil 105°C+3.5% Sulfur power 500 hrs  S= Low Resistance Pulse withstanding
<b>TA</b>	<b>06</b>	<b>M</b>	<b>xxxx</b>	<b>D</b>	<b>T</b>	<b>L</b>	<b>T</b>
TA : Thin Film Array /Networks Convex	06 : 0603 (1608)	M : *4, TCR 50ppm N : *4, TCR 25ppm	E24+E192  **Please see remark for detail explanation	F : ±1% D : ±0.5% C : ±0.25% B : ±0.1%	T : Reeled	L= Sn base (Lead free)	D : Equal values B : Two pairs . T : Different Values
<b>WM_Q / MM / WM</b>	<b>04</b>	<b>C</b>	<b>1002</b>	<b>B</b>	<b>T</b>	<b>L</b>	<b>Q</b>
WM: MELF Thin Film , AEC-Q200 Compliant	04 (0204) 07 (0207)	B : TCR 50 ppm C : TCR 25 ppm N : TCR 50 ppm, Power O : TCR 25 ppm, Power D : Low TCR 15 ppm E : Low TCR 10 ppm P : Low TCR 15 ppm, Power Q : Low TCR 10 ppm, Power	E24+E192  **Please see remark for detail explanation	B : ± 0.1% C : ± 0.25% D : ± 0.5% F : ± 1%	T : 7" Reel & Taped	L= Sn base (Lead free)	Q= AEC-Q200 Compliant

Type code	Size code	Functional code		Resistance	Tolerance	Packaging code	Termination code
<b>TTL</b>	<b>12</b>	<b>Q (Power Rating)</b>	<b>N (TCR)</b>	<b>XXXX</b>	<b>F</b>	<b>T</b>	<b>L</b>
TTL: Thin Film Foil Current Sensor ( High Power /Low TCR )	25 : 2512 (6432) 12 : 1206 (3216) 08 : 0805 (2012) 06 : 0603 (1608) 04 : 0402 (1005)	Q: 2W P: 1W M: 1/2W K: 1/3W J: 1/4W I: 1/5W H: 1/8W G: 1/10W	N : 50 ppm O : 75 ppm P : 100 ppm Q : 150 ppm R : 200 ppm U : 350 ppm	e.g: R020 = 20mΩ R0050 = 5mΩ R2L5 = 2.5mΩ	D : ± 0.5% F : ± 1% G : ± 2% J : ± 5%	T : 7" Reel & Taped	L= Sn base (Lead free)
<b>WW</b>	<b>12</b>	<b>F (TCR)</b>		<b>XXXX</b>	<b>F</b>	<b>T</b>	<b>L</b>
WW: Low Ohmic Thin Film Current Sensor ( >20mR ~900m )	25 : 2512 (6432) 20 : 2010 (5025) 12 : 1206 (3216) 08 : 0805 (2012) 06 : 0603 (1608) 04 : 0402 (1005)	F: 75 ppm G:100ppm H:75 ppm,High Power		e.g: R100= 100mΩ R050= 50mΩ	D : ± 0.5% F : ± 1% G : ± 2% J : ± 5%	T : 7" Reel & Taped	L= Sn base (Lead free)

- Remark:
1. Detail product part number, functional code, tolerance combination; please refer to specific data sheet.
  2. E24 (J tol.): 2 significant digits followed by No. of zeros and a blank, e.g.: 3ohm = 3R0\_, 10ohm = 100\_, 220ohm = 221\_, 56Kohm = 563\_ ,("\_" means blank).
  3. E24+E192 (F tol.): 3 significant digits followed by No. of zeros, e.g.: 3Ω = 3R00, 10Ω = 10R0, 220Ω = 2200, 56KΩ = 5602.
  4. Example: ("\_" means a blank)  
Chip-R 0805 size, 4.3ohm, 5%, Normal type, SnPb termination, 5000pcs taped in reel: WR08X4R3\_JTL
  5. 1218 standard packing Q'ty is 3Kpcs in 10" reel and packing code is T code

■ Chip Resistor Selection Guide

■ General Purpose Chip-R

Series	Size	Rated Power	TCR (ppm/°C)*	Tolerance	Resistance
WR25X	2512 (6432)	1W	±100	±1%	1 ~ 10MΩ
			±200	±5%	
WR18X	1218 (3248)	1W	±100	±1%	
			±200	±5%	
WR20X	2010 (5025)	3/4W	±100	±1%	
			±200	±5%	
WR10X	1210 (3225)	1/3W	±100	±1%	
			±200	±5%	
WR12X	1206 (3216)	1/4W	±100	±1%	
				±5%	
WR08X	0805 (2012)	1/8W	±100	±1%	
				±5%	
WR06X	0603 (1608)	1/10W	±100	±1%	
				±5%	
WR04X	0402 (1005)	1/16W	±100	±1%	
				±5%	
WR02X	0201 (0603)	1/20W	±200	±1%	
			±200	±5%	
WR01X	01005 (0402)	1/32W	±200	±1%	4.7 ~ 1MΩ
			±200	±5%	

Remark: 1. Detailed resistance vs. TCR and ordering code please refer to specific specifications.  
 2. Jumper resistor is not designed for fusing applications, designers shall apply dedicate fusible resistor or standard fuse in application circuits.  
 3. WRxxW defines for ±1% < 10ohm or > 1Mohm,

■ Thick Film Low Ohm Chip-R

Series	Size	Rated Power	TCR (ppm/°C)	Tolerance	Resistance
WW25X	2512 (6432)	1W	≤ 1500**	±1%, ±5%	0.015Ω ~ 0.976Ω
WW25W			±1000**	±1%, ±5%	0.010Ω ~ 0.910Ω
WW18X	1218 (3248)	1W	≤ 1500**	±1% ±5%	0.020Ω ~ 0.976Ω 0.015Ω ~ 0.976Ω
WW20X	2010 (5025)	1/2W	≤ 1500**	±1%, ±5%	0.020Ω ~ 0.976Ω
WW20W		3/4W	±1000**	±1%, ±5%	0.010Ω ~ 0.910Ω
WW10X	1210 (3225)	1/3W	±200	±1%, ±5%	0.020Ω ~ 0.976Ω
WW10W		2/3W	±600**	±1%, ±5%	0.010Ω ~ 0.910Ω
WW12X	1206 (3216)	1/4W	≤ 1500**	±1%, ±5%	0.010Ω ~ 0.976Ω
WW12W		1/3W	±1000**	±1%, ±5%	0.010Ω ~ 0.910Ω
WW08X	0805 (2012)	1/8W	≤ 1500**	±1%, ±5%	0.020Ω ~ 0.976Ω
WW08W		1/4W	±1000**	±1%, ±5%	0.010Ω ~ 0.910Ω
WW06X	0603 (1608)	1/10W	≤ 500**	±1%, ±5%	0.100Ω ~ 0.976Ω
WW06W		1/8W	≤ 400**	±1%, ±5%	0.050Ω ~ 0.910Ω
WW04X	0402 (1005)	1/16W	≤ 600**	±1%, ±5%	0.100Ω ~ 0.976Ω

Remark: 1. Detailed resistance vs. TCR and ordering code please refer to specific specifications.  
 2. Resistance value will be changed by soldering condition and design of soldering pad, please design products in consideration of this change.

■ Thick Film Power Low Ohm Chip-R

Series	Size	Rated Power	TCR (ppm/°C)	Tolerance	Resistance
WW25T	2512 (6432)	3W	100ppm	±1%, ±5%	0.100Ω ~ 0.910Ω
WW25P		2W	< 0.1Ω: 150ppm ≥ 0.1Ω: 100ppm	±1%, ±5%	0.040Ω ~ 0.976Ω
WW25W_J		2W	100 ~ 1000ppm	±1%, ±5%	0.010Ω ~ 0.910Ω
WW20P	2010 (5025)	1W	< 0.1Ω: 150ppm ≥ 0.1Ω: 100ppm	±1%, ±5%	0.040Ω ~ 0.976Ω
WW20W_H		1W	100ppm	±1%, ±5%	0.050Ω ~ 0.910Ω
WW10P	1210 (3225)	1/2W	< 0.1Ω: 500ppm ≥ 0.1Ω: 200ppm	±1%, ±5%	0.020Ω ~ 0.976Ω
WW10W_G		3/4W	100ppm	±1%, ±5%	0.050Ω ~ 0.910Ω
WW12P	1206 (3216)	1/2W	< 0.1Ω: 200ppm ≥ 0.1Ω: 100ppm	±1%, ±5%	0.020Ω ~ 0.976Ω
WW12W_G		3/4W	100 ~ 1000ppm	±1%, ±5%	0.010Ω ~ 0.910Ω
WW08P	0805 (2012)	1/3W	< 0.1Ω: 200ppm ≥ 0.1Ω: 150ppm	±1%, ±5%	0.047Ω ~ 0.976Ω
WW08W_F		1/2W	100 ~ 1000ppm	±1%, ±5%	0.010Ω ~ 0.910Ω
WW06P	0603 (1608)	1/4W	< 0.1Ω: 250ppm ≥ 0.1Ω: 200ppm	±1%, ±5%	0.047Ω ~ 0.976Ω
WW06W_D		1/4W	200 ~ 400ppm	±1%, ±5%	0.050Ω ~ 0.910Ω
WW04P	0402 (1005)	1/8W	< 0.1Ω: 300ppm ≥ 0.1Ω: 200ppm	±1%, ±5%	0.100Ω ~ 0.976Ω
WW12C	1206 (3216)	1/2W	< 0.02Ω: 150ppm ≥ 0.02Ω: 100ppm	±1%, ±5%	0.020 ~ 0.100Ω
WW08C	0805 (2012)	1/3W	< 0.03Ω: 200ppm ≥ 0.03Ω: 100ppm	±1%, ±5%	0.010 ~ 0.100Ω
WW06C	0603 (1608)	1/4W	< 0.051Ω: 0~+350ppm ≥ 0.051Ω: ±150ppm	±1%, ±5%	0.010 ~ 0.100Ω
WW04C	0402 (1005)	1/8W	< 0.051Ω: 0~+350ppm ≥ 0.051Ω: ±150ppm	±1%, ±5%	0.025 ~ 0.100Ω
WW02C	0201 (0603)	1/10W	0 ~ +500ppm	±1%, ±5%	±5%: 0.020 ~ 0.100Ω ±1%: 0.040 ~ 0.100Ω

■ Metal Low Ohm Sensing Type Chip-R

Series	Size	Rated Power	TCR (ppm/°C)*	Tolerance	Resistance	
WW59M	5931 (15079)	5W	±75	±1%, ±5%	5, 10mΩ	
WW25A	2512 (6432)	3W	±70/±50	±1%, ±5%	5,6,8,10,12,15,18,20,25,30,33,35,40,50, 60, 75, 80, 100mΩ	
WW25B		3W	±70/±50	±1%, ±5%	2,3,4,5,6,7,8,9,10,20mΩ	
WW25N		2W	±70	±1%, ±5%	1,2,3,4,5,6,7,8,9,10,12,15,20,25,30,33,35,40,50,70,75,80,100mΩ	
WW25K		2W	±70	±1%, ±5%	1, 2, 3, 4, 5, 10, 15, 20mΩ	
WW25D		2W	±100/±50	±1%, ±5%, ±0.5%	2 ~ 700 mΩ	
WW25R		2W	±70	±1%, ±5%	1, 2, 3, 4, 5, 6, 7, 8, 9, 10mΩ	
WW25M		1W	±70	±1%, ±5%	1,2,3,4,5,6,7,8,9,10,12,15,20,25,30,33,35,40,50,70,75,80,100mΩ	
WW25J		1W	±70	±1%, ±5%	1, 2, 3, 4, 5, 10,15, 20mΩ	
WW25Q		1W	±70	±1%, ±5%	1, 2, 3, 4, 5, 6, 7, 8, 9, 10, 11, 12, 13, 14, 15mΩ	
WW20N		2010 (5025)	1W	±70	±1%, ±5%	5, 10, 15, 20, 25mΩ
WW20M	1/2W		±70	±1%, ±5%	5, 10, 15, 20, 25mΩ	
WW12N	1206 (3216)	1W	±70	±1%, ±5%	5, 8, 10, 15, 18, 20, 25, 30mΩ	
WW12K		1W	±70	±1%, ±5%	3, 4, 5, 6, 7, 8, 9, 10, 15, 20, 25mΩ	
WW12R		1W	±70	±1%, ±5%	1, 2, 3, 4, 5, 6, 7, 8, 9, 10, 11, 12, 13, 14, 15mΩ	
WW12D		1W	±100/ 50	±1%, ±5%	3 ~ 700mΩ	
WW12M		1/2W	±70	±1%, ±5%	5, 8, 10, 15, 20, 25, 30mΩ	
WW12J		1/2W	±70	±1%, ±5%	3, 4, 5, 6, 7, 8, 9, 10, 15, 20, 25 mΩ	
WW08D		0805 (2012)	3/4W	±100/ 50	±1%, ±5%	3 ~ 500mΩ
WW08R			1/2W	±70	±1%, ±5%	2, 3, 4, 5, 6, 7, 8, 9, 10 mΩ
WW08K	1/2W		±100	±1%, ±5%	5, 6, 7, 8, 9, 10 mΩ	
WW08J	1/4W		±100	±1%, ±5%	5, 6, 7, 8, 9, 10 mΩ	
WW06R	0603 (1608)	1/3W	±70	±1%, ±5%	5, 10 mΩ	
WW06D		1/2W	±100/ 50	±1%, ±5%	5 ~ 75 mΩ	

Remark: 1. Detailed resistance vs. TCR and ordering code please refer to specific specifications.  
2. Resistance value will be changed by soldering condition and design of soldering pad, please design products in consideration of this change.

■ Chip Resistor Array

Series	Size	Rated Power	TCR (ppm/°C)	Termination	Tolerance	Resistance
WA06X/ SA06X	1206 (0603x4)	1/10W	±200	Convex	±1%, ±5%	10 ~ 1MΩ
WA06T	1206 (0603x4)	1/10W	±200	Concave	±1%, ±5%	
WA06Y/ SA06Y	0606 (0603x2)	1/10W	±200	Convex	±1%, ±5%	
WA04X/ SA04X	0804 (0402x4)	1/16W	±200	Convex	±1%, ±5%	
WA04T	0804 (0402x4)	1/16W	±300	Concave	±1%, ±5%	
WA04F	0804 (0402x4)	1/16W	±300	Reverse Concave	±1%, ±5%	
WA04Y/ SA04Y	0404 (0402x2)	1/16W	±200	Convex	±1%, ±5%	
WA04U	0404 (0402x2)	1/16W	±300	Concave	±1%, ±5%	
WA04G	0804 (0402x2)	1/16W	±300	Reverse Concave	±1%, ±5%	
WA06W	1606 (0402x8)	1/16W	±200	Convex	±1%, ±5%	
WA02A	0502 (0201x4)	1/32W	±200	Flat	±1%, ±5%	±5% = 10 ~ 1MΩ
WA02B	0202 (0201x2)	1/32W	±200	Flat	±1%, ±5%	±1% = 10 ~ 100KΩ
WA02F	0502 (0201x4)	1/32W	±200	Reverse Flat	±1%, ±5%	±5% = 10 ~ 1MΩ
WA02G	0202 (0201x2)	1/32W	±200	Reverse Flat	±1%, ±5%	±1% = 10 ~ 100KΩ

Remark: 1. Detailed resistance vs. TCR and ordering code please refer to specific specifications.  
2. Resistance value will be changed by soldering condition and design of soldering pad, please design products in consideration of this change.

■ Chip Attenuator

Series	Size	Type	Termination	Tolerance	Attenuation	Impedance
WA04P	0404 (0402x2)	4P3R, Π type	Convex	±0.1dB ~ ±2.5dB	0, 0.5dB ~ 20dB	50Ω

■ Chip Resistor Network

Series	Size	Rated Power	TCR (ppm/°C)	Termination	Tolerance	Resistance
WT04X	1206 (10P8R)	1/16W	±200	Convex	±5%	10 ~ 100KΩ

■ High Power Chip-R

Series	Size	Rated Power	TCR (ppm/°C)	Tolerance	Resistance	
WF25P	2512 (6432)	2W	±100	±1%, ±5%	Jumper; 1 ~ 1MΩ	
WF20P	2010 (5025)	1W	±100		Jumper; 1 ~ 1MΩ	
WF10P	1210 (3225)	1/2W	±100		Jumper; 1 ~ 1MΩ	
WF12P	1206 (3216)	1/2W	±100		Jumper; 1 ~ 10MΩ	
WF08P	0805 (2012)	1/4W	±100		Jumper; 1 ~ 10MΩ	
WF06P	0603 (1608)	1/8W	±100		Jumper; 1 ~ 1MΩ	
WF04P	0402 (1005)	1/8W	±100		Jumper; 1 ~ 1MΩ	
WF25A	2512 (6432)	3W	±100		±1%, ±5%	1 ~ 1MΩ
WF20A	2010 (5025)	1.5W	±100			1 ~ 1MΩ
WF10A	1210 (3225)	3/4W	±100			1 ~ 1MΩ
WF12A	1206 (3216)	3/4W	±100	1 ~ 1MΩ		
WF08A	0805 (2012)	1/2W	±100	1 ~ 1MΩ		
WF06A	0603 (1608)	1/3W	±100	1 ~ 1MΩ		
MF25E	2512 (6432)	2W	±100	1 ~ 1MΩ		
MF20E	2010 (5025)	1W	±100	1 ~ 1MΩ		
MF10E	1210 (3225)	1/2W	±100	1 ~ 1MΩ		
MF12E	1206 (3216)	3/4W	±100	1 ~ 1MΩ		
MF08E	0805 (2012)	1/2W	±100	1 ~ 1MΩ		
MF06E	0603 (1608)	1/3W	±100	1 ~ 1MΩ		

■ Surge Chip-R

Series	Size	Rated Power	TCR(ppm/°C)	Tolerance	Resistance
WK25S	2512 (6432)	1W	≤200	±5%, ±10%, ±20%	0.27 ~ 22MΩ
WK20S	2010 (5025)	3/4W	≤200		0.27 ~ 22MΩ
WK10S	1210 (3225)	1/2W	≤200		0.27 ~ 22MΩ
WK12S	1206 (3216)	1/3W	≤200		0.27 ~ 22MΩ
WK08S	0805 (2012)	1/4W	≤200		0.27 ~ 22MΩ
WK06S	0603 (1608)	1/4W	≤200		1 ~ 10MΩ
WF04S	0402 (1005)	1/8W	≤200	±5%, ±10%	1 ~ 1MΩ
MK08S	0805 (2012)	1/3W	≤100	±0.5%, ±1%, ±5%	1 ~ 1MΩ
MK06S	0603 (1608)	1/4W	≤100	±0.5%, ±1%, ±5%	1 ~ 1MΩ

■ Automotive Chip-R (Details please refer Automotive resistor introduction)

Series	Size	Rated Power	TCR(ppm/°C)	Tolerance	Resistance
MR25	2512 (6432)	1W	±200	±1%, ±5%	1~ 10MΩ
MR20	2010 (5025)	1/2W	±200		1~ 10MΩ
MR18	1218 (3248)	1W	±200		1~ 10MΩ
MR10	1210 (3225)	1/2W	±200		1~ 10MΩ
MR12	1206 (3216)	1/4W	±200		1~ 10MΩ
MR08	0805 (2012)	1/8W	±200		1~ 10MΩ
MR06	0603 (1608)	1/10W	±200		1~ 10MΩ
MR04	0402 (1005)	1/16W	±200		1~ 10MΩ
MR02	0201 (0603)	1/20W	±200		1~ 10MΩ

■ Anti-Sulfuration Chip-R (Details please refer Anti-sulfur resistor introduction)

Series	Size	Rated Power	TCR(ppm/°C)	Tolerance	Resistance
SR25	2512 (6432)	1W	±200	±1%, ±5%	1~ 10MΩ
SR20	2010 (5025)	1/2W	±200		1~ 10MΩ
SR12	1206 (3216)	1/4W	≤200		1~ 10MΩ
SR08	0805 (2012)	1/8W	≤200		1~ 10MΩ
SR06	0603 (1608)	1/10W	≤200		1~ 10MΩ
SR04	0402 (1005)	1/16W	≤200		1~ 10MΩ

■ High Ohm Chip-R

Series	Size	Rated Power	TCR(ppm/°C)	Tolerance	Resistance
WF12G	1206 (3216)	1/4W	≤200	±1%, ±5%	11M ~ 100MΩ
WF08G	0805 (2012)	1/8W	≤200	±1%, ±5%	11M ~ 100MΩ
WF06G	0603 (1608)	1/10W	≤200	±1%, ±5%	11M ~ 100MΩ
WF04G	0402 (1005)	1/16W	≤300	±1%, ±5%	11M ~ 30MΩ

■ High Voltage Chip-R

Series	Size	Rated Power	TCR(ppm/°C)	Voltage (V)	Tolerance	Resistance
WK25N	2512 (6432)	1W	≤200	2000	±5%, ±10%, ±20%	4.7M ~ 16MΩ
WK20N	2010 (5025)	1/2W	≤200	1500	±5%, ±10%, ±20%	1M ~ 16MΩ
WK25V	2512 (6432)	1W	≤200	800	±1%, ±5%	47~ 51MΩ
WK20V	2010 (5025)	1/2W	≤200	500	±1%, ±5%	47~ 51MΩ
WK12V	1206 (3216)	1/4W	≤200	500	±1%, ±5%	47~ 51MΩ
WK08V	0805 (2012)	1/8W	≤200	400	±1%, ±5%	47~ 51MΩ
WK06V	0603 (1608)	1/10W	≤200	200	±1%, ±5%	47~ 10MΩ
WF25N UL	2512 (6432)	1W	≤200	3000	±1%, ±5%	100K~ 100MΩ
WF20N UL	2010 (5025)	1/2W	≤200	2000	±1%, ±5%	100K~ 100MΩ
WF12N UL	1206 (3216)	1/4W	≤200	800	±1%, ±5%	100K~ 100MΩ
WF08N UL	0805 (2012)	1/8W	≤200	400	±1%, ±5%	100K~ 22MΩ
WF06N UL	0603 (1608)	1/10W	≤200	200	±1%, ±5%	100K~ 22MΩ

■ Trimmable Chip-R

Series	Size	Rated Power	TCR(ppm/°C)	Tolerance	Resistance
WK12M	1206 (3216)	1/8W	≤200	0/-20%, 0/-30%	1 ~ 4.7MΩ
WK08M	0805 (2012)	1/10W	≤200	0/-20%, 0/-30%	1 ~ 4.7MΩ
WK06M	0603 (1608)	1/16W	≤100	0/-20%, 0/-30%	10~ 4.7MΩ

■ Total lead free Chip-R (Pb < 100ppm)

Series	Size	Rated Power	TCR(ppm/°C)	Tolerance	Resistance
WR25X_R	2512 (6432)	1W	≤200	±1%, ±5%	1~ 10MΩ
WR18X_R	1218 (3248)	1W	≤200	±1%, ±5%	1~ 10MΩ
WR20X_R	2010 (5025)	1/2W	≤200	±1%, ±5%	1~ 10MΩ
WR10X_R	1210 (3225)	1/3W	≤200	±1%, ±5%	1~ 10MΩ
WR12X_R	1206 (3216)	1/4W	≤200	±1%, ±5%	1~ 10MΩ
WR08X_R	0805 (2012)	1/8W	≤200	±1%, ±5%	1~ 10MΩ
WR06X_R	0603 (1608)	1/10W	≤200	±1%, ±5%	1~ 10MΩ
WR04X_R	0402 (1005)	1/16W	≤200	±1%, ±5%	1~ 10MΩ
WR02X_R	0201 (0603)	1/20W	≤200	±1%, ±5%	1~ 10MΩ
WR01X_R	01005 (0402)	1/32W	≤200	±1%, ±5%	10~ 1MΩ
WA04X_R	0402x4	1/16W	≤200	±1%, ±5%	10 ~ 1MΩ
WA06X_R	0603x4	1/10W	≤200	±1%, ±5%	10 ~ 1MΩ



■ Thick Film High Precision Chip-R

Series	Size	Rated Power	TCR(ppm/°C)	Tolerance	Resistance
WF25H	2512 (6432)	1W	≤100	±0.1%, ±0.5%	10 ~ 1MΩ
WF20H	2010 (5025)	1/2W	≤100	±0.1%, ±0.5%	10 ~ 1MΩ
WF10H	1210 (3225)	1/3W	≤100	±0.1%, ±0.5%	10 ~ 1MΩ
WF12H	1206 (3216)	1/4W	≤100	±0.1%, ±0.5%	10 ~ 1MΩ
WF08H	0805 (2012)	1/8W	≤100	±0.1%, ±0.5%	10 ~ 1MΩ
WF06H	0603 (1608)	1/10W	≤100	±0.1%, ±0.5%	10 ~ 1MΩ
WF04H	0402 (1005)	1/16W	≤100	±0.1%, ±0.5%	10 ~ 1MΩ
WK02H	0201 (0603)	1/20W	≤200	±0.1%, ±0.5%	10 ~ 1MΩ
WF12K	1206 (3216)	1/4W	≤50	±0.1%, ±0.5%	10 ~ 1MΩ
WF08K	0805 (2012)	1/8W	≤50	±0.1%, ±0.5%	10 ~ 1MΩ
WF06K	0603 (1608)	1/10W	≤50	±0.1%, ±0.5%	10 ~ 1MΩ
WF04K	0402 (1005)	1/16W	≤50	±0.1%, ±0.5%	100 ~ 1MΩ
WK12K	1206 (3216)	1/4W	≤50	±0.1%, ±0.5%	10 ~ 1MΩ
WK08K	0805 (2012)	1/8W	≤50	±0.1%, ±0.5%	10 ~ 1MΩ
WK06K	0603 (1608)	1/10W	≤50/100	±0.1%, ±0.5%	10 ~ 1MΩ
WK04K	0402 (1005)	1/16W	≤50/100	±0.1%, ±0.5%	100 ~ 1MΩ
WK02K	0201 (0603)	1/20W	≤50/100	±0.1%, ±0.5%	10 ~ 1MΩ

■ Thin Film Precision Chip-R

Series	Size	Rated Power	TCR(ppm/°C)	Tolerance	Resistance
WF25T	2512(6432)	3/4W	±50	±0.01%,±0.02%, ±0.05%, ±0.1%, ±0.25%, ±0.5%, ±1%	1 ~ 3MΩ
WF25Q	2512(6432)	1W	±50	±0.01%,±0.02%, ±0.05%, ±0.1%, ±0.25%, ±0.5%, ±1%	1 ~ 3MΩ
WF20T	2010(5025)	1/2W	±50	±0.01%,±0.02%, ±0.05%, ±0.1%, ±0.25%, ±0.5%, ±1%	4.7 ~ 3MΩ
WF20Q	2010(5025)	3/4W	±50	±0.01%,±0.02%, ±0.05%, ±0.1%, ±0.25%, ±0.5%, ±1%	4.7 ~ 3MΩ
WF10T	1210(3225)	1/4W	±50	±0.01%,±0.02%, ±0.05%, ±0.1%, ±0.25%, ±0.5%, ±1%	4.7 ~ 2.49MΩ
WF10Q	1210(3225)	2/5W	±50	±0.01%,±0.02%, ±0.05%, ±0.1%, ±0.25%, ±0.5%, ±1%	4.7 ~ 2.5MΩ
WF12T	1206(3216)	1/8W	±50	±0.01%,±0.02%, ±0.05%, ±0.1%, ±0.25%, ±0.5%, ±1%	1 ~ 2.49MΩ
WF12Q	1206(3216)	1/4W	±50	±0.01%,±0.02%, ±0.05%, ±0.1%, ±0.25%, ±0.5%, ±1%	1 ~ 2.5MΩ
WF08T	0805(2012)	1/10W	±50	±0.01%,±0.02%, ±0.05%, ±0.1%, ±0.25%, ±0.5%, ±1%	4.7 ~ 2MΩ
WF08Q	0805(2012)	1/8W	±50	±0.01%,±0.02%, ±0.05%, ±0.1%, ±0.25%, ±0.5%, ±1%	4.7 ~ 2MΩ
WF06T	0603 (1608)	1/16W	±50	±0.01%,±0.02%, ±0.05%, ±0.1%, ±0.25%, ±0.5%, ±1%	3.9 ~ 1MΩ
WF06Q	0603 (1608)	1/10W	±50	±0.01%,±0.02%, ±0.05%, ±0.1%, ±0.25%, ±0.5%, ±1%	3.9 ~ 1MΩ
WF04T	0402 (1005)	1/16W	±50	±0.01%,±0.02%, ±0.05%, ±0.1%, ±0.25%, ±0.5%, ±1%	10 ~ 255KΩ
WF04Q	0402 (1005)	1/10W	±50	±0.01%,±0.02%, ±0.05%, ±0.1%, ±0.25%, ±0.5%, ±1%	10 ~ 255KΩ
WF02T	0201 (0603)	1/32W	±50	±0.01%, ±0.05%, ±0.1%, ±0.5%, ±1%	100 ~ 12KΩ
WF02Q	0201 (0603)	1/20W	±50	±0.5%, ±1%	27 ~ 22.1KΩ
WF25U	2512(6432)	3/4W	±25	±0.01%,±0.02%, ±0.05%, ±0.1%, ±0.25%, ±0.5%, ±1%	1 ~ 3MΩ
WF25R	2512(6432)	1W	±25	±0.01%,±0.02%, ±0.05%, ±0.1%, ±0.25%, ±0.5%, ±1%	1 ~ 3MΩ
WF20U	2010(5025)	1/2W	±25	±0.01%,±0.02%, ±0.05%, ±0.1%, ±0.25%, ±0.5%, ±1%	4.7 ~ 3MΩ
WF20R	2010(5025)	3/4W	±25	±0.01%,±0.02%, ±0.05%, ±0.1%, ±0.25%, ±0.5%, ±1%	4.7 ~ 3MΩ
WF10U	1210(3225)	1/4W	±25	±0.01%,±0.02%, ±0.05%, ±0.1%, ±0.25%, ±0.5%, ±1%	4.7 ~ 2.49MΩ
WF10R	1210(3225)	2/5W	±25	±0.01%,±0.02%, ±0.05%, ±0.1%, ±0.25%, ±0.5%, ±1%	4.7 ~ 2.49MΩ
WF12U	1206(3216)	1/8W	±25	±0.01%,±0.02%, ±0.05%, ±0.1%, ±0.25%, ±0.5%, ±1%	1 ~ 2.49MΩ
WF12R	1206(3216)	1/4W	±25	±0.01%,±0.02%, ±0.05%, ±0.1%, ±0.25%, ±0.5%, ±1%	1 ~ 2.5MΩ
WF08U	0805 (2012)	1/10W	±25	±0.01%,±0.02%, ±0.05%, ±0.1%, ±0.25%, ±0.5%, ±1%	4.7 ~ 2MΩ
WF08R	0805 (2012)	1/8W	±25	±0.01%,±0.02%, ±0.05%, ±0.1%, ±0.25%, ±0.5%, ±1%	4.7 ~ 2MΩ
WF06U	0603 (1608)	1/16W	±25	±0.01%,±0.02%, ±0.05%, ±0.1%, ±0.25%, ±0.5%, ±1%	3.9 ~ 1MΩ
WF06R	0603 (1608)	1/10W	±25	±0.01%,±0.02%, ±0.05%, ±0.1%, ±0.25%, ±0.5%, ±1%	3.9 ~ 1MΩ
WF04U	0402 (1005)	1/16W	±25	±0.01%,±0.02%, ±0.05%, ±0.1%, ±0.25%, ±0.5%, ±1%	10 ~ 255KΩ
WF04R	0402 (1005)	1/10W	±25	±0.01%,±0.02%, ±0.05%, ±0.1%, ±0.25%, ±0.5%, ±1%	10 ~ 255KΩ
WF02U	0201 (0603)	1/32W	±25	±0.01%, ±0.05%, ±0.1%, ±0.5%, ±1%	100 ~ 12KΩ
WF02R	0201 (0603)	1/20W	±25	±0.5%, ±1%	27 ~ 12KΩ
WF25F	2512(6432)	1W	±15	±0.01%,±0.02%, ±0.05%, ±0.1%, ±0.25%, ±0.5%, ±1%	10 ~ 1.5MΩ
WF20F	2010(5025)	3/4W	±15	±0.01%,±0.02%, ±0.05%, ±0.1%, ±0.25%, ±0.5%, ±1%	10 ~ 1MΩ
WF10F	1210(3225)	2/5W	±15	±0.01%,±0.02%, ±0.05%, ±0.1%, ±0.25%, ±0.5%, ±1%	10 ~ 600KΩ
WF12F	1206(3216)	1/4W	±15	±0.01%,±0.02%, ±0.05%, ±0.1%, ±0.25%, ±0.5%, ±1%	4.7 ~ 500KΩ
WF08F	0805(2012)	1/8W	±15	±0.01%,±0.02%, ±0.05%, ±0.1%, ±0.25%, ±0.5%, ±1%	4.7 ~ 400KΩ
WF06F	0603 (1608)	1/10W	±15	±0.01%,±0.02%, ±0.05%, ±0.1%, ±0.25%, ±0.5%, ±1%	4.7 ~ 200KΩ
WF04F	0402 (1005)	1/10W	±15	±0.01%,±0.02%, ±0.05%, ±0.1%, ±0.25%, ±0.5%, ±1%	10 ~ 100KΩ
WF25W	2512(6432)	1W	±10	±0.01%,±0.02%, ±0.05%, ±0.1%, ±0.25%, ±0.5%, ±1%	10 ~ 1.5MΩ
WF20W	2010(5025)	3/4W	±10	±0.01%,±0.02%, ±0.05%, ±0.1%, ±0.25%, ±0.5%, ±1%	10 ~ 1MΩ
WF10W	1210(3225)	2/5W	±10	±0.01%,±0.02%, ±0.05%, ±0.1%, ±0.25%, ±0.5%, ±1%	10 ~ 600KΩ
WF12W	1206(3216)	1/4W	±10	±0.01%,±0.02%, ±0.05%, ±0.1%, ±0.25%, ±0.5%, ±1%	4.7 ~ 500KΩ
WF08W	0805(2012)	1/8W	±10	±0.01%,±0.02%, ±0.05%, ±0.1%, ±0.25%, ±0.5%, ±1%	4.7 ~ 400KΩ
WF06W	0603 (1608)	1/10W	±10	±0.01%,±0.02%, ±0.05%, ±0.1%, ±0.25%, ±0.5%, ±1%	4.7 ~ 200KΩ
WF04W	0402 (1005)	1/10W	±10	±0.01%,±0.02%, ±0.05%, ±0.1%, ±0.25%, ±0.5%, ±1%	10 ~ 100KΩ
WF25Z	2512(6432)	1W	±5	±0.01%,±0.02%, ±0.05%, ±0.1%, ±0.25%, ±0.5%, ±1%	4.7 ~ 600KΩ
WF20Z	2010(5025)	3/4W	±5	±0.01%,±0.02%, ±0.05%, ±0.1%, ±0.25%, ±0.5%, ±1%	4.7 ~ 360KΩ
WF10Z	1210(3225)	2/5W	±5	±0.01%,±0.02%, ±0.05%, ±0.1%, ±0.25%, ±0.5%, ±1%	4.7 ~ 150KΩ
WF12Z	1206(3216)	1/4W	±5	±0.01%,±0.02%, ±0.05%, ±0.1%, ±0.25%, ±0.5%, ±1%	4.7 ~ 150KΩ
WF08Z	0805(2012)	1/8W	±5	±0.01%,±0.02%, ±0.05%, ±0.1%, ±0.25%, ±0.5%, ±1%	4.7 ~ 100KΩ
WF06Z	0603 (1608)	1/10W	±5	±0.01%,±0.02%, ±0.05%, ±0.1%, ±0.25%, ±0.5%, ±1%	4.7 ~ 50KΩ
WF04Z	0402 (1005)	1/10W	±5	±0.01%,±0.02%, ±0.05%, ±0.1%, ±0.25%, ±0.5%, ±1%	10 ~ 10KΩ
WF25B	2512(6432)	1W	±3	±0.01%,±0.02%, ±0.05%, ±0.1%, ±0.25%, ±0.5%, ±1%	4.7 ~ 600KΩ
WF20B	2010(5025)	3/4W	±3	±0.01%,±0.02%, ±0.05%, ±0.1%, ±0.25%, ±0.5%, ±1%	4.7 ~ 360KΩ
WF10B	1210(3225)	2/5W	±3	±0.01%,±0.02%, ±0.05%, ±0.1%, ±0.25%, ±0.5%, ±1%	4.7 ~ 150KΩ

■ Thin Film Precision Chip-R (Continuous)

Series	Size	Rated Power	TCR(ppm/°C)	Tolerance	Resistance
WF12B	1206(3216)	1/4W	±3	±0.01%,±0.02%, ±0.05%, ±0.1%, ±0.25%, ±0.5%, ±1%	4.7 ~ 120KΩ
WF08B	0805(2012)	1/8W	±3	±0.01%,±0.02%, ±0.05%, ±0.1%, ±0.25%, ±0.5%, ±1%	4.7 ~ 80KΩ
WF06B	0603 (1608)	1/10W	±3	±0.01%,±0.02%, ±0.05%, ±0.1%, ±0.25%, ±0.5%, ±1%	4.7 ~ 40KΩ
WF04B	0402 (1005)	1/10W	±3	±0.01%,±0.02%, ±0.05%, ±0.1%, ±0.25%, ±0.5%, ±1%	10 ~ 8KΩ
WF25C	2512(6432)	1W	±2	±0.01%,±0.02%, ±0.05%, ±0.1%, ±0.25%, ±0.5%, ±1%	4.7 ~ 600KΩ
WF20C	2010(5025)	3/4W	±2	±0.01%,±0.02%, ±0.05%, ±0.1%, ±0.25%, ±0.5%, ±1%	4.7 ~ 360KΩ
WF10C	1210(3225)	2/5W	±2	±0.01%,±0.02%, ±0.05%, ±0.1%, ±0.25%, ±0.5%, ±1%	4.7 ~ 150KΩ
WF12C	1206(3216)	1/4W	±2	±0.01%,±0.02%, ±0.05%, ±0.1%, ±0.25%, ±0.5%, ±1%	4.7 ~ 120KΩ
WF08C	0805(2012)	1/8W	±2	±0.01%,±0.02%, ±0.05%, ±0.1%, ±0.25%, ±0.5%, ±1%	4.7 ~ 80KΩ
WF06C	0603 (1608)	1/10W	±2	±0.01%,±0.02%, ±0.05%, ±0.1%, ±0.25%, ±0.5%, ±1%	4.7 ~ 40KΩ
WF04C	0402 (1005)	1/10W	±2	±0.01%,±0.02%, ±0.05%, ±0.1%, ±0.25%, ±0.5%, ±1%	10 ~ 8KΩ

■Thin Film Professional Chip-R (AEC-Q200 Compliant)

Series	Size	Rated Power	TCR(ppm/°C)	Tolerance	Resistance
WF25T_Q	2512(6432)	3/4W	±50	±0.02%, ±0.05%, ±0.1%, ±0.25%, ±0.5%, ±1%	10Ω ~ 1.5MΩ
WF25Q_Q	2512(6432)	1W	±50	±0.02%, ±0.05%, ±0.1%, ±0.25%, ±0.5%, ±1%	10Ω ~ 1.5MΩ
WF20T_Q	2010(5025)	1/2W	±50	±0.02%, ±0.05%, ±0.1%, ±0.25%, ±0.5%, ±1%	10Ω ~ 1.5MΩ
WF20Q_Q	2010(5025)	3/4W	±50	±0.02%, ±0.05%, ±0.1%, ±0.25%, ±0.5%, ±1%	10Ω ~ 1.5MΩ
WF10T_Q	1210(3225)	1/4W	±50	±0.02%, ±0.05%, ±0.1%, ±0.25%, ±0.5%, ±1%	10Ω ~ 1MΩ
WF10Q_Q	1210(3225)	2/5W	±50	±0.02%, ±0.05%, ±0.1%, ±0.25%, ±0.5%, ±1%	10Ω ~ 1MΩ
WF12T_Q	1206(3216)	1/8W	±50	±0.02%, ±0.05%, ±0.1%, ±0.25%, ±0.5%, ±1%	4.7Ω ~ 1MΩ
WF12Q_Q	1206(3216)	1/4W	±50	±0.02%, ±0.05%, ±0.1%, ±0.25%, ±0.5%, ±1%	4.7Ω ~ 1MΩ
WF08T_Q	0805(2012)	1/10W	±50	±0.02%, ±0.05%, ±0.1%, ±0.25%, ±0.5%, ±1%	4.7Ω ~ 1MΩ
WF08Q_Q	0805(2012)	1/8W	±50	±0.02%, ±0.05%, ±0.1%, ±0.25%, ±0.5%, ±1%	4.7Ω ~ 1MΩ
WF06T_Q	0603(1608)	1/16W	±50	±0.02%, ±0.05%, ±0.1%, ±0.25%, ±0.5%, ±1%	4.7Ω ~ 330KΩ
WF06Q_Q	0603(1608)	1/10W	±50	±0.02%, ±0.05%, ±0.1%, ±0.25%, ±0.5%, ±1%	4.7Ω ~ 330KΩ
WF04T_Q	0402(1005)	1/16W	±50	±0.02%, ±0.05%, ±0.1%, ±0.25%, ±0.5%, ±1%	10Ω ~ 100KΩ
WF04Q_Q	0402(1005)	1/10W	±50	±0.02%, ±0.05%, ±0.1%, ±0.25%, ±0.5%, ±1%	10Ω ~ 100KΩ
WF25U_Q	2512(6432)	3/4W	±25	±0.02%, ±0.05%, ±0.1%, ±0.25%, ±0.5%, ±1%	10Ω ~ 1.5MΩ
WF25R_Q	2512(6432)	1W	±25	±0.02%, ±0.05%, ±0.1%, ±0.25%, ±0.5%, ±1%	10Ω ~ 1.5MΩ
WF20U_Q	2010(5025)	1/2W	±25	±0.02%, ±0.05%, ±0.1%, ±0.25%, ±0.5%, ±1%	10Ω ~ 1.5MΩ
WF20R_Q	2010(5025)	3/4W	±25	±0.02%, ±0.05%, ±0.1%, ±0.25%, ±0.5%, ±1%	10Ω ~ 1.5MΩ
WF10U_Q	1210(3225)	1/4W	±25	±0.02%, ±0.05%, ±0.1%, ±0.25%, ±0.5%, ±1%	10Ω ~ 1MΩ
WF10R_Q	1210(3225)	2/5W	±25	±0.02%, ±0.05%, ±0.1%, ±0.25%, ±0.5%, ±1%	10Ω ~ 1MΩ
WF12U_Q	1206(3216)	1/8W	±25	±0.02%, ±0.05%, ±0.1%, ±0.25%, ±0.5%, ±1%	4.7Ω ~ 1MΩ
WF12R_Q	1206(3216)	1/4W	±25	±0.02%, ±0.05%, ±0.1%, ±0.25%, ±0.5%, ±1%	4.7Ω ~ 1MΩ
WF08U_Q	0805(2012)	1/10W	±25	±0.02%, ±0.05%, ±0.1%, ±0.25%, ±0.5%, ±1%	4.7Ω ~ 1MΩ
WF08R_Q	0805(2012)	1/8W	±25	±0.02%, ±0.05%, ±0.1%, ±0.25%, ±0.5%, ±1%	4.7Ω ~ 1MΩ
WF06U_Q	0603(1608)	1/16W	±25	±0.02%, ±0.05%, ±0.1%, ±0.25%, ±0.5%, ±1%	4.7Ω ~ 330KΩ
WF06R_Q	0603(1608)	1/10W	±25	±0.02%, ±0.05%, ±0.1%, ±0.25%, ±0.5%, ±1%	4.7Ω ~ 330KΩ
WF04U_Q	0402(1005)	1/16W	±25	±0.02%, ±0.05%, ±0.1%, ±0.25%, ±0.5%, ±1%	10Ω ~ 100KΩ
WF04R_Q	0402(1005)	1/10W	±25	±0.02%, ±0.05%, ±0.1%, ±0.25%, ±0.5%, ±1%	10Ω ~ 100KΩ
WF25F_Q	2512(6432)	1W	±15	±0.02%, ±0.05%, ±0.1%, ±0.25%, ±0.5%, ±1%	10Ω ~ 1.5MΩ
WF20F_Q	2010(5025)	3/4W	±15	±0.02%, ±0.05%, ±0.1%, ±0.25%, ±0.5%, ±1%	10Ω ~ 1MΩ
WF10F_Q	1210(3225)	2/5W	±15	±0.02%, ±0.05%, ±0.1%, ±0.25%, ±0.5%, ±1%	10Ω ~ 600KΩ
WF12F_Q	1206(3216)	1/4W	±15	±0.02%, ±0.05%, ±0.1%, ±0.25%, ±0.5%, ±1%	4.7Ω ~ 500KΩ
WF08F_Q	0805(2012)	1/8W	±15	±0.02%, ±0.05%, ±0.1%, ±0.25%, ±0.5%, ±1%	4.7Ω ~ 400KΩ
WF06F_Q	0603(1608)	1/10W	±15	±0.02%, ±0.05%, ±0.1%, ±0.25%, ±0.5%, ±1%	4.7Ω ~ 150KΩ
WF04F_Q	0402(1005)	1/10W	±15	±0.02%, ±0.05%, ±0.1%, ±0.25%, ±0.5%, ±1%	10Ω ~ 60KΩ
WF25W_Q	2512(6432)	1W	±10	±0.02%, ±0.05%, ±0.1%, ±0.25%, ±0.5%, ±1%	10Ω ~ 1.5MΩ
WF20W_Q	2010(5025)	3/4W	±10	±0.02%, ±0.05%, ±0.1%, ±0.25%, ±0.5%, ±1%	10Ω ~ 1MΩ
WF10W_Q	1210(3225)	2/5W	±10	±0.02%, ±0.05%, ±0.1%, ±0.25%, ±0.5%, ±1%	10Ω ~ 600KΩ
WF12W_Q	1206(3216)	1/4W	±10	±0.02%, ±0.05%, ±0.1%, ±0.25%, ±0.5%, ±1%	4.7Ω ~ 500KΩ
WF08W_Q	0805(2012)	1/8W	±10	±0.02%, ±0.05%, ±0.1%, ±0.25%, ±0.5%, ±1%	4.7Ω ~ 400KΩ
WF06W_Q	0603(1608)	1/10W	±10	±0.02%, ±0.05%, ±0.1%, ±0.25%, ±0.5%, ±1%	4.7Ω ~ 150KΩ
WF04W_Q	0402(1005)	1/10W	±10	±0.02%, ±0.05%, ±0.1%, ±0.25%, ±0.5%, ±1%	10Ω ~ 60KΩ
WF25Z_Q	2512(6432)	1W	±5	±0.02%, ±0.05%, ±0.1%, ±0.25%, ±0.5%, ±1%	10Ω ~ 600KΩ
WF20Z_Q	2010(5025)	3/4W	±5	±0.02%, ±0.05%, ±0.1%, ±0.25%, ±0.5%, ±1%	10Ω ~ 360KΩ
WF10Z_Q	1210(3225)	2/5W	±5	±0.02%, ±0.05%, ±0.1%, ±0.25%, ±0.5%, ±1%	10Ω ~ 150KΩ
WF12Z_Q	1206(3216)	1/4W	±5	±0.02%, ±0.05%, ±0.1%, ±0.25%, ±0.5%, ±1%	4.7Ω ~ 150KΩ
WF08Z_Q	0805(2012)	1/8W	±5	±0.02%, ±0.05%, ±0.1%, ±0.25%, ±0.5%, ±1%	4.7Ω ~ 100KΩ
WF06Z_Q	0603(1608)	1/10W	±5	±0.02%, ±0.05%, ±0.1%, ±0.25%, ±0.5%, ±1%	4.7Ω ~ 50KΩ
WF04Z_Q	0402(1005)	1/10W	±5	±0.02%, ±0.05%, ±0.1%, ±0.25%, ±0.5%, ±1%	10Ω ~ 10KΩ
WF25B_Q	2512(6432)	1W	±3	±0.02%, ±0.05%, ±0.1%, ±0.25%, ±0.5%, ±1%	10Ω ~ 600KΩ
WF20B_Q	2010(5025)	3/4W	±3	±0.02%, ±0.05%, ±0.1%, ±0.25%, ±0.5%, ±1%	10Ω ~ 360KΩ
WF10B_Q	1210(3225)	2/5W	±3	±0.02%, ±0.05%, ±0.1%, ±0.25%, ±0.5%, ±1%	10Ω ~ 150KΩ
WF12B_Q	1206(3216)	1/4W	±3	±0.02%, ±0.05%, ±0.1%, ±0.25%, ±0.5%, ±1%	4.7Ω ~ 120KΩ
WF08B_Q	0805(2012)	1/8W	±3	±0.02%, ±0.05%, ±0.1%, ±0.25%, ±0.5%, ±1%	4.7Ω ~ 80KΩ
WF06B_Q	0603(1608)	1/10W	±3	±0.02%, ±0.05%, ±0.1%, ±0.25%, ±0.5%, ±1%	4.7Ω ~ 40KΩ
WF04B_Q	0402(1005)	1/10W	±3	±0.02%, ±0.05%, ±0.1%, ±0.25%, ±0.5%, ±1%	10Ω ~ 8KΩ
WF25C_Q	2512(6432)	1W	±2	±0.02%, ±0.05%, ±0.1%, ±0.25%, ±0.5%, ±1%	10Ω ~ 600KΩ
WF20C_Q	2010(5025)	3/4W	±2	±0.02%, ±0.05%, ±0.1%, ±0.25%, ±0.5%, ±1%	10Ω ~ 360KΩ
WF10C_Q	1210(3225)	2/5W	±2	±0.02%, ±0.05%, ±0.1%, ±0.25%, ±0.5%, ±1%	10Ω ~ 150KΩ
WF12C_Q	1206(3216)	1/4W	±2	±0.02%, ±0.05%, ±0.1%, ±0.25%, ±0.5%, ±1%	4.7Ω ~ 120KΩ
WF08C_Q	0805(2012)	1/8W	±2	±0.02%, ±0.05%, ±0.1%, ±0.25%, ±0.5%, ±1%	4.7Ω ~ 80KΩ
WF06C_Q	0603(1608)	1/10W	±2	±0.02%, ±0.05%, ±0.1%, ±0.25%, ±0.5%, ±1%	4.7Ω ~ 40KΩ
WF04C_Q	0402(1005)	1/10W	±2	±0.02%, ±0.05%, ±0.1%, ±0.25%, ±0.5%, ±1%	10Ω ~ 8KΩ

■ Thin Film Anti-Sulfuration Chip-R

Series	Size	Rated Power	TCR(ppm/°C)	Tolerance	Resistance
SF25Q	2512(6432)	1W	±50	±0.05%, ±0.1%, ±0.25%, ±0.5%, ±1%	1Ω ~ 3MΩ
SF20Q	2010(5025)	3/4W	±50	±0.05%, ±0.1%, ±0.25%, ±0.5%, ±1%	4.7Ω ~ 3MΩ
SF10Q	1210(3225)	2/5W	±50	±0.05%, ±0.1%, ±0.25%, ±0.5%, ±1%	4.7Ω ~ 2.5MΩ
SF12Q	1206(3216)	1/4W	±50	±0.05%, ±0.1%, ±0.25%, ±0.5%, ±1%	1Ω ~ 2.5MΩ
SF08Q	0805(2012)	1/8W	±50	±0.05%, ±0.1%, ±0.25%, ±0.5%, ±1%	4.7Ω ~ 2MΩ
SF06Q	0603(1608)	1/10W	±50	±0.05%, ±0.1%, ±0.25%, ±0.5%, ±1%	4.7Ω ~ 1MΩ
SF04Q	0402(1005)	1/10W	±50	±0.05%, ±0.1%, ±0.25%, ±0.5%, ±1%	10Ω ~ 255KΩ
SF25T	2512(6432)	3/4W	±50	±0.05%, ±0.1%, ±0.25%, ±0.5%, ±1%	1Ω ~ 3MΩ
SF20T	2010(5025)	1/2W	±50	±0.05%, ±0.1%, ±0.25%, ±0.5%, ±1%	4.7Ω ~ 3MΩ
SF10T	1210(3225)	1/4W	±50	±0.05%, ±0.1%, ±0.25%, ±0.5%, ±1%	4.7Ω ~ 2.5MΩ
SF12T	1206(3216)	1/8W	±50	±0.05%, ±0.1%, ±0.25%, ±0.5%, ±1%	1Ω ~ 2.5MΩ
SF08T	0805(2012)	1/10W	±50	±0.05%, ±0.1%, ±0.25%, ±0.5%, ±1%	4.7Ω ~ 2MΩ
SF06T	0603(1608)	1/16W	±50	±0.05%, ±0.1%, ±0.25%, ±0.5%, ±1%	4.7Ω ~ 1MΩ
SF04T	0402(1005)	1/16W	±50	±0.05%, ±0.1%, ±0.25%, ±0.5%, ±1%	10Ω ~ 255KΩ
SF25R	2512(6432)	1W	±25	±0.05%, ±0.1%, ±0.25%, ±0.5%, ±1%	1Ω ~ 3MΩ
SF20R	2010(5025)	3/4W	±25	±0.05%, ±0.1%, ±0.25%, ±0.5%, ±1%	4.7Ω ~ 3MΩ
SF10R	1210(3225)	2/5W	±25	±0.05%, ±0.1%, ±0.25%, ±0.5%, ±1%	4.7Ω ~ 2.5MΩ
SF12R	1206(3216)	1/4W	±25	±0.05%, ±0.1%, ±0.25%, ±0.5%, ±1%	1Ω ~ 2.5MΩ
SF08R	0805(2012)	1/8W	±25	±0.05%, ±0.1%, ±0.25%, ±0.5%, ±1%	4.7Ω ~ 2MΩ
SF06R	0603(1608)	1/10W	±25	±0.05%, ±0.1%, ±0.25%, ±0.5%, ±1%	4.7Ω ~ 1MΩ
SF04R	0402(1005)	1/10W	±25	±0.05%, ±0.1%, ±0.25%, ±0.5%, ±1%	10Ω ~ 255KΩ
SF25U	2512(6432)	3/4W	±25	±0.05%, ±0.1%, ±0.25%, ±0.5%, ±1%	1Ω ~ 3MΩ
SF20U	2010(5025)	1/2W	±25	±0.05%, ±0.1%, ±0.25%, ±0.5%, ±1%	4.7Ω ~ 3MΩ
SF10U	1210(3225)	1/4W	±25	±0.05%, ±0.1%, ±0.25%, ±0.5%, ±1%	4.7Ω ~ 2.5MΩ
SF12U	1206(3216)	1/8W	±25	±0.05%, ±0.1%, ±0.25%, ±0.5%, ±1%	1Ω ~ 2.5MΩ
SF08U	0805(2012)	1/10W	±25	±0.05%, ±0.1%, ±0.25%, ±0.5%, ±1%	4.7Ω ~ 2MΩ
SF06U	0603(1608)	1/16W	±25	±0.05%, ±0.1%, ±0.25%, ±0.5%, ±1%	4.7Ω ~ 1MΩ
SF04U	0402(1005)	1/16W	±25	±0.05%, ±0.1%, ±0.25%, ±0.5%, ±1%	10Ω ~ 255KΩ

■ Thin Film Anti-Sulfuration Chip-R (AEC-Q200 Compliant & ASTM B-809)

Series	Size	Rated Power	TCR(ppm/°C)	Tolerance	Resistance
SF25Q_Q	2512(6432)	1W	±50	±0.05%, ±0.1%, ±0.25%, ±0.5%, ±1%	10Ω ~ 1.5MΩ
SF20Q_Q	2010(5025)	3/4W	±50	±0.05%, ±0.1%, ±0.25%, ±0.5%, ±1%	10Ω ~ 1.5MΩ
SF10Q_Q	1210(3225)	2/5W	±50	±0.05%, ±0.1%, ±0.25%, ±0.5%, ±1%	10Ω ~ 1MΩ
SF12Q_Q	1206(3216)	1/4W	±50	±0.05%, ±0.1%, ±0.25%, ±0.5%, ±1%	10Ω ~ 1MΩ
SF08Q_Q	0805(2012)	1/8W	±50	±0.05%, ±0.1%, ±0.25%, ±0.5%, ±1%	10Ω ~ 1MΩ
SF06Q_Q	0603(1608)	1/10W	±50	±0.05%, ±0.1%, ±0.25%, ±0.5%, ±1%	4.7Ω ~ 330KΩ
SF04Q_Q	0402(1005)	1/10W	±50	±0.05%, ±0.1%, ±0.25%, ±0.5%, ±1%	10Ω ~ 100KΩ
SF25T_Q	2512(6432)	3/4W	±50	±0.05%, ±0.1%, ±0.25%, ±0.5%, ±1%	10Ω ~ 1.5MΩ
SF20T_Q	2010(5025)	1/2W	±50	±0.05%, ±0.1%, ±0.25%, ±0.5%, ±1%	10Ω ~ 1.5MΩ
SF10T_Q	1210(3225)	1/4W	±50	±0.05%, ±0.1%, ±0.25%, ±0.5%, ±1%	10Ω ~ 1MΩ
SF12T_Q	1206(3216)	1/8W	±50	±0.05%, ±0.1%, ±0.25%, ±0.5%, ±1%	10Ω ~ 1MΩ
SF08T_Q	0805(2012)	1/10W	±50	±0.05%, ±0.1%, ±0.25%, ±0.5%, ±1%	10Ω ~ 1MΩ
SF06T_Q	0603(1608)	1/16W	±50	±0.05%, ±0.1%, ±0.25%, ±0.5%, ±1%	4.7Ω ~ 330KΩ
SF04T_Q	0402(1005)	1/16W	±50	±0.05%, ±0.1%, ±0.25%, ±0.5%, ±1%	10Ω ~ 100KΩ
SF25R_Q	2512(6432)	1W	±25	±0.05%, ±0.1%, ±0.25%, ±0.5%, ±1%	10Ω ~ 1.5MΩ
SF20R_Q	2010(5025)	3/4W	±25	±0.05%, ±0.1%, ±0.25%, ±0.5%, ±1%	10Ω ~ 1.5MΩ
SF10R_Q	1210(3225)	2/5W	±25	±0.05%, ±0.1%, ±0.25%, ±0.5%, ±1%	10Ω ~ 1MΩ
SF12R_Q	1206(3216)	1/4W	±25	±0.05%, ±0.1%, ±0.25%, ±0.5%, ±1%	10Ω ~ 1MΩ
SF08R_Q	0805(2012)	1/8W	±25	±0.05%, ±0.1%, ±0.25%, ±0.5%, ±1%	10Ω ~ 1MΩ
SF06R_Q	0603(1608)	1/10W	±25	±0.05%, ±0.1%, ±0.25%, ±0.5%, ±1%	4.7Ω ~ 330KΩ
SF04R_Q	0402(1005)	1/10W	±25	±0.05%, ±0.1%, ±0.25%, ±0.5%, ±1%	10Ω ~ 100KΩ
SF25U_Q	2512(6432)	3/4W	±25	±0.05%, ±0.1%, ±0.25%, ±0.5%, ±1%	10Ω ~ 1.5MΩ
SF20U_Q	2010(5025)	1/2W	±25	±0.05%, ±0.1%, ±0.25%, ±0.5%, ±1%	10Ω ~ 1.5MΩ
SF10U_Q	1210(3225)	1/4W	±25	±0.05%, ±0.1%, ±0.25%, ±0.5%, ±1%	10Ω ~ 1MΩ
SF12U_Q	1206(3216)	1/8W	±25	±0.05%, ±0.1%, ±0.25%, ±0.5%, ±1%	10Ω ~ 1MΩ
SF08U_Q	0805(2012)	1/10W	±25	±0.05%, ±0.1%, ±0.25%, ±0.5%, ±1%	10Ω ~ 1MΩ
SF06U_Q	0603(1608)	1/16W	±25	±0.05%, ±0.1%, ±0.25%, ±0.5%, ±1%	4.7Ω ~ 330KΩ
SF04U_Q	0402(1005)	1/16W	±25	±0.05%, ±0.1%, ±0.25%, ±0.5%, ±1%	10Ω ~ 100KΩ
SF25F_Q	2512(6432)	1W	±15	±0.05%, ±0.1%, ±0.25%, ±0.5%, ±1%	10Ω ~ 1.5MΩ
SF20F_Q	2010(5025)	3/4W	±15	±0.05%, ±0.1%, ±0.25%, ±0.5%, ±1%	10Ω ~ 900KΩ
SF10F_Q	1210(3225)	2/5W	±15	±0.05%, ±0.1%, ±0.25%, ±0.5%, ±1%	10Ω ~ 400KΩ
SF12F_Q	1206(3216)	1/4W	±15	±0.05%, ±0.1%, ±0.25%, ±0.5%, ±1%	10Ω ~ 300KΩ
SF08F_Q	0805(2012)	1/8W	±15	±0.05%, ±0.1%, ±0.25%, ±0.5%, ±1%	10Ω ~ 200KΩ
SF06F_Q	0603(1608)	1/10W	±15	±0.05%, ±0.1%, ±0.25%, ±0.5%, ±1%	10Ω ~ 100KΩ
SF04F_Q	0402(1005)	1/10W	±15	±0.05%, ±0.1%, ±0.25%, ±0.5%, ±1%	10Ω ~ 20KΩ
SF25W_Q	2512(6432)	1W	±10	±0.05%, ±0.1%, ±0.25%, ±0.5%, ±1%	10Ω ~ 1.5MΩ
SF20W_Q	2010(5025)	3/4W	±10	±0.05%, ±0.1%, ±0.25%, ±0.5%, ±1%	10Ω ~ 900KΩ
SF10W_Q	1210(3225)	2/5W	±10	±0.05%, ±0.1%, ±0.25%, ±0.5%, ±1%	10Ω ~ 400KΩ
SF12W_Q	1206(3216)	1/4W	±10	±0.05%, ±0.1%, ±0.25%, ±0.5%, ±1%	10Ω ~ 300KΩ
SF08W_Q	0805(2012)	1/8W	±10	±0.05%, ±0.1%, ±0.25%, ±0.5%, ±1%	10Ω ~ 200KΩ
SF06W_Q	0603(1608)	1/10W	±10	±0.05%, ±0.1%, ±0.25%, ±0.5%, ±1%	10Ω ~ 100KΩ
SF04W_Q	0402(1005)	1/10W	±10	±0.05%, ±0.1%, ±0.25%, ±0.5%, ±1%	10Ω ~ 20KΩ
SF25Z_Q	2512(6432)	1W	±5	±0.05%, ±0.1%, ±0.25%, ±0.5%, ±1%	10Ω ~ 600KΩ
SF20Z_Q	2010(5025)	3/4W	±5	±0.05%, ±0.1%, ±0.25%, ±0.5%, ±1%	10Ω ~ 360KΩ
SF10Z_Q	1210(3225)	2/5W	±5	±0.05%, ±0.1%, ±0.25%, ±0.5%, ±1%	10Ω ~ 150KΩ
SF12Z_Q	1206(3216)	1/4W	±5	±0.05%, ±0.1%, ±0.25%, ±0.5%, ±1%	10Ω ~ 150KΩ
SF08Z_Q	0805(2012)	1/8W	±5	±0.05%, ±0.1%, ±0.25%, ±0.5%, ±1%	10Ω ~ 100KΩ
SF06Z_Q	0603(1608)	1/10W	±5	±0.05%, ±0.1%, ±0.25%, ±0.5%, ±1%	10Ω ~ 50KΩ
SF04Z_Q	0402(1005)	1/10W	±5	±0.05%, ±0.1%, ±0.25%, ±0.5%, ±1%	10Ω ~ 10KΩ

■ Thin Film Anti-Sulfuration Chip-R (ASTM-B809 & under Oil 105°C+3.5% Sulfur power 500 hours)

Series	Size	Rated Power	TCR(ppm/°C)	Tolerance	Resistance
SF25Q_A	2512(6432)	1W	±50	±0.05%, ±0.1%, ±0.25%, ±0.5%, ±1%	1Ω ~ 3MΩ
SF20Q_A	2010(5025)	3/4W	±50	±0.05%, ±0.1%, ±0.25%, ±0.5%, ±1%	4.7Ω ~ 3MΩ
SF10Q_A	1210(3225)	2/5W	±50	±0.05%, ±0.1%, ±0.25%, ±0.5%, ±1%	4.7Ω ~ 2.5MΩ
SF12Q_A	1206(3216)	1/4W	±50	±0.05%, ±0.1%, ±0.25%, ±0.5%, ±1%	1Ω ~ 2.5MΩ
SF08Q_A	0805(2012)	1/8W	±50	±0.05%, ±0.1%, ±0.25%, ±0.5%, ±1%	4.7Ω ~ 2MΩ
SF06Q_A	0603(1608)	1/10W	±50	±0.05%, ±0.1%, ±0.25%, ±0.5%, ±1%	4.7Ω ~ 1MΩ
SF04Q_A	0402(1005)	1/10W	±50	±0.05%, ±0.1%, ±0.25%, ±0.5%, ±1%	10Ω ~ 255KΩ
SF25R_A	2512(6432)	1W	±25	±0.05%, ±0.1%, ±0.25%, ±0.5%, ±1%	1Ω ~ 3MΩ
SF20R_A	2010(5025)	3/4W	±25	±0.05%, ±0.1%, ±0.25%, ±0.5%, ±1%	4.7Ω ~ 3MΩ
SF10R_A	1210(3225)	2/5W	±25	±0.05%, ±0.1%, ±0.25%, ±0.5%, ±1%	4.7Ω ~ 2.5MΩ
SF12R_A	1206(3216)	1/4W	±25	±0.05%, ±0.1%, ±0.25%, ±0.5%, ±1%	1Ω ~ 2.5MΩ
SF08R_A	0805(2012)	1/8W	±25	±0.05%, ±0.1%, ±0.25%, ±0.5%, ±1%	4.7Ω ~ 2MΩ
SF06R_A	0603(1608)	1/10W	±25	±0.05%, ±0.1%, ±0.25%, ±0.5%, ±1%	4.7Ω ~ 1MΩ
SF04R_A	0402(1005)	1/10W	±25	±0.05%, ±0.1%, ±0.25%, ±0.5%, ±1%	10Ω ~ 255KΩ
SF25T_A	2512(6432)	1W	±50	±0.05%, ±0.1%, ±0.25%, ±0.5%, ±1%	1Ω ~ 3MΩ
SF20T_A	2010(5025)	3/4W	±50	±0.05%, ±0.1%, ±0.25%, ±0.5%, ±1%	4.7Ω ~ 3MΩ
SF10T_A	1210(3225)	2/5W	±50	±0.05%, ±0.1%, ±0.25%, ±0.5%, ±1%	4.7Ω ~ 2.5MΩ
SF12T_A	1206(3216)	1/8W	±50	±0.05%, ±0.1%, ±0.25%, ±0.5%, ±1%	1Ω ~ 2.5MΩ
SF08T_A	0805(2012)	1/10W	±50	±0.05%, ±0.1%, ±0.25%, ±0.5%, ±1%	4.7Ω ~ 2MΩ
SF06T_A	0603(1608)	1/16W	±50	±0.05%, ±0.1%, ±0.25%, ±0.5%, ±1%	4.7Ω ~ 1MΩ
SF04T_A	0402(1005)	1/16W	±50	±0.05%, ±0.1%, ±0.25%, ±0.5%, ±1%	10Ω ~ 255KΩ
SF25U_A	2512(6432)	1W	±25	±0.05%, ±0.1%, ±0.25%, ±0.5%, ±1%	1Ω ~ 3MΩ
SF20U_A	2010(5025)	3/4W	±25	±0.05%, ±0.1%, ±0.25%, ±0.5%, ±1%	4.7Ω ~ 3MΩ
SF10U_A	1210(3225)	2/5W	±25	±0.05%, ±0.1%, ±0.25%, ±0.5%, ±1%	4.7Ω ~ 2.5MΩ
SF12U_A	1206(3216)	1/8W	±25	±0.05%, ±0.1%, ±0.25%, ±0.5%, ±1%	1Ω ~ 2.5MΩ
SF08U_A	0805(2012)	1/10W	±25	±0.05%, ±0.1%, ±0.25%, ±0.5%, ±1%	4.7Ω ~ 2MΩ
SF06U_A	0603(1608)	1/16W	±25	±0.05%, ±0.1%, ±0.25%, ±0.5%, ±1%	4.7Ω ~ 1MΩ
SF04U_A	0402(1005)	1/16W	±25	±0.05%, ±0.1%, ±0.25%, ±0.5%, ±1%	10Ω ~ 255KΩ
SF25F_A	2512(6432)	1W	±15	±0.01%, ±0.02%, ±0.05%, ±0.1%, ±0.25%, ±0.5%, ±1%	10Ω ~ 1.5MΩ
SF20F_A	2010(5025)	3/4W	±15	±0.01%, ±0.02%, ±0.05%, ±0.1%, ±0.25%, ±0.5%, ±1%	10Ω ~ 1MΩ
SF10F_A	1210(3225)	2/5W	±15	±0.01%, ±0.02%, ±0.05%, ±0.1%, ±0.25%, ±0.5%, ±1%	10Ω ~ 600KΩ
SF12F_A	1206(3216)	1/4W	±15	±0.01%, ±0.02%, ±0.05%, ±0.1%, ±0.25%, ±0.5%, ±1%	4.7Ω ~ 500KΩ
SF08F_A	0805(2012)	1/8W	±15	±0.01%, ±0.02%, ±0.05%, ±0.1%, ±0.25%, ±0.5%, ±1%	4.7Ω ~ 400KΩ
SF06F_A	0603(1608)	1/10W	±15	±0.01%, ±0.02%, ±0.05%, ±0.1%, ±0.25%, ±0.5%, ±1%	4.7Ω ~ 200KΩ
SF04F_A	0402(1005)	1/10W	±15	±0.01%, ±0.02%, ±0.05%, ±0.1%, ±0.25%, ±0.5%, ±1%	10Ω ~ 100KΩ
SF25W_A	2512(6432)	1W	±10	±0.01%, ±0.02%, ±0.05%, ±0.1%, ±0.25%, ±0.5%, ±1%	10Ω ~ 1.5MΩ
SF20W_A	2010(5025)	3/4W	±10	±0.01%, ±0.02%, ±0.05%, ±0.1%, ±0.25%, ±0.5%, ±1%	10Ω ~ 1MΩ
SF10W_A	1210(3225)	2/5W	±10	±0.01%, ±0.02%, ±0.05%, ±0.1%, ±0.25%, ±0.5%, ±1%	10Ω ~ 600KΩ
SF12W_A	1206(3216)	1/4W	±10	±0.01%, ±0.02%, ±0.05%, ±0.1%, ±0.25%, ±0.5%, ±1%	4.7Ω ~ 500KΩ
SF08W_A	0805(2012)	1/8W	±10	±0.01%, ±0.02%, ±0.05%, ±0.1%, ±0.25%, ±0.5%, ±1%	4.7Ω ~ 400KΩ
SF06W_A	0603(1608)	1/10W	±10	±0.01%, ±0.02%, ±0.05%, ±0.1%, ±0.25%, ±0.5%, ±1%	4.7Ω ~ 200KΩ
SF04W_A	0402(1005)	1/10W	±10	±0.01%, ±0.02%, ±0.05%, ±0.1%, ±0.25%, ±0.5%, ±1%	10Ω ~ 100KΩ
SF25Z_A	2512(6432)	1W	±5	±0.05%, ±0.1%, ±0.25%, ±0.5%, ±1%	4.7Ω ~ 600KΩ
SF20Z_A	2010(5025)	3/4W	±5	±0.05%, ±0.1%, ±0.25%, ±0.5%, ±1%	4.7Ω ~ 360KΩ
SF10Z_A	1210(3225)	2/5W	±5	±0.05%, ±0.1%, ±0.25%, ±0.5%, ±1%	4.7Ω ~ 150KΩ
SF12Z_A	1206(3216)	1/4W	±5	±0.05%, ±0.1%, ±0.25%, ±0.5%, ±1%	4.7Ω ~ 150KΩ
SF08Z_A	0805(2012)	1/8W	±5	±0.05%, ±0.1%, ±0.25%, ±0.5%, ±1%	4.7Ω ~ 100KΩ
SF06Z_A	0603(1608)	1/10W	±5	±0.05%, ±0.1%, ±0.25%, ±0.5%, ±1%	4.7Ω ~ 50KΩ
SF04Z_A	0402(1005)	1/10W	±5	±0.05%, ±0.1%, ±0.25%, ±0.5%, ±1%	10Ω ~ 10KΩ

■ TaN Thin Film Chip-R (Auto Grade, AEC-Q200 Qualified & ASTM-B809)

Series	Size	Rated Power	TCR(ppm/°C)	Tolerance	Resistance
MF12Q	1206(3216)	0.4W	±50	±0.05%, ±0.1%, ±0.25%, ±0.5%, ±1%	10Ω ~ 1MΩ
MF08Q	0805(2012)	0.2W	±50	±0.05%, ±0.1%, ±0.25%, ±0.5%, ±1%	10Ω ~ 350KΩ
MF06Q	0603(1608)	0.15W	±50	±0.05%, ±0.1%, ±0.25%, ±0.5%, ±1%	40Ω ~ 130KΩ
MF04Q	0402(1005)	0.0625W	±50	±0.05%, ±0.1%, ±0.25%, ±0.5%, ±1%	40Ω ~ 35KΩ
MF12R	1206(3216)	0.4W	±25	±0.05%, ±0.1%, ±0.25%, ±0.5%, ±1%	10Ω ~ 1MΩ
MF08R	0805(2012)	0.2W	±25	±0.05%, ±0.1%, ±0.25%, ±0.5%, ±1%	10Ω ~ 350KΩ
MF06R	0603(1608)	0.15W	±25	±0.05%, ±0.1%, ±0.25%, ±0.5%, ±1%	40Ω ~ 130KΩ
MF04R	0402(1005)	0.0625W	±25	±0.05%, ±0.1%, ±0.25%, ±0.5%, ±1%	40Ω ~ 35KΩ
MF12F	1206(3216)	0.4W	±15	±0.05%, ±0.1%, ±0.25%, ±0.5%, ±1%	10Ω ~ 1MΩ
MF08F	0805(2012)	0.2W	±15	±0.05%, ±0.1%, ±0.25%, ±0.5%, ±1%	10Ω ~ 350KΩ
MF06F	0603(1608)	0.15W	±15	±0.05%, ±0.1%, ±0.25%, ±0.5%, ±1%	40Ω ~ 130KΩ
MF04F	0402(1005)	0.0625W	±15	±0.05%, ±0.1%, ±0.25%, ±0.5%, ±1%	40Ω ~ 35KΩ
MF12W	1206(3216)	0.4W	±10	±0.05%, ±0.1%, ±0.25%, ±0.5%, ±1%	10Ω ~ 1MΩ
MF08W	0805(2012)	0.2W	±10	±0.05%, ±0.1%, ±0.25%, ±0.5%, ±1%	10Ω ~ 350KΩ
MF06W	0603(1608)	0.15W	±10	±0.05%, ±0.1%, ±0.25%, ±0.5%, ±1%	40Ω ~ 130KΩ
MF04W	0402(1005)	0.0625W	±10	±0.05%, ±0.1%, ±0.25%, ±0.5%, ±1%	40Ω ~ 35KΩ

■ Precision Thin Film Chip-R Array: Convex Termination

Series	Size	Rated Power	TCR (ppm/°C)	Termination	Tolerance	Resistance
TA06N	0603*4 (4R)	1/10W, 2/5W	±25	Convex	±0.1%, ±0.25%, ±0.5%, ±1.0%	20Ω ~ 200KΩ
TA06M	0603*4 (4R)	1/10W, 2/5W	±50	Convex	±0.1%, ±0.25%, ±0.5%, ±1.0%	20Ω ~ 200KΩ

■ MELF Thin Film Resistor (AEC-Q200 Compliant)

Series	Size	Rated Power	TCR(ppm/°C)	Tolerance	Resistance
WM04B	0204	1/4W	±50	±0.1%, ±0.25%, ±0.5%, ±1%	0,2Ω ~ 1MΩ
WM04N	0204	2/5W	±50	±0.1%, ±0.25%, ±0.5%, ±1%	0,2Ω ~ 1MΩ
WM04C	0204	1/4W	±25	±0.1%, ±0.25%, ±0.5%, ±1%	10Ω ~ 1MΩ
WM04O	0204	2/5W	±25	±0.1%, ±0.25%, ±0.5%, ±1%	10Ω ~ 1MΩ
WM04D	0204	1/4W	±15	±0.1%, ±0.25%, ±0.5%, ±1%	49.9Ω ~ 250KΩ
WM04P	0204	2/5W	±15	±0.1%, ±0.25%, ±0.5%, ±1%	49.9Ω ~ 250KΩ
WM04E	0204	1/4W	±10	±0.1%, ±0.25%, ±0.5%, ±1%	49.9Ω ~ 25KΩ
WM04Q	0204	2/5W	±10	±0.1%, ±0.25%, ±0.5%, ±1%	49.9Ω ~ 25KΩ
WM07B	0207	1/2W	±50	±0.1%, ±0.25%, ±0.5%, ±1%	0,2Ω ~ 1MΩ
WM07N	0207	1W	±50	±0.1%, ±0.25%, ±0.5%, ±1%	0,2Ω ~ 1MΩ
WM07C	0207	1/2W	±25	±0.1%, ±0.25%, ±0.5%, ±1%	10Ω ~ 1MΩ
WM07O	0207	1W	±25	±0.1%, ±0.25%, ±0.5%, ±1%	10Ω ~ 1MΩ
WM07D	0207	1/2W	±15	±0.1%, ±0.25%, ±0.5%, ±1%	49.9Ω ~ 250KΩ
WM07P	0207	1W	±15	±0.1%, ±0.25%, ±0.5%, ±1%	49.9Ω ~ 250KΩ
WM07E	0207	1/2W	±10	±0.1%, ±0.25%, ±0.5%, ±1%	49.9Ω ~ 25KΩ
WM07Q	0207	1W	±10	±0.1%, ±0.25%, ±0.5%, ±1%	49.9Ω ~ 25KΩ

■ Thin Film Low ohmic Current Sensor

Series	Size	Rated Power	TCR (ppm/°C)	Tolerance	Resistance
WW25F	2512 (6432)	2W	±75	±0.5%, ±1%	101mΩ ~ 900mΩ
WW25G			±100		21mΩ ~ 900mΩ
WW20F	2010 (5025)	1W	±75	±0.5%, ±1%	101mΩ ~ 900mΩ
WW20G			±100		21mΩ ~ 900mΩ
WW12F	1206 (3216)	1/2W	±75	±0.5%, ±1%	101mΩ ~ 900mΩ
WW12G			±100		21mΩ ~ 900mΩ
WW12H			±75		101mΩ ~ 900mΩ
WW08F	0805 (2012)	1/4W	±75	±0.5%, ±1%	101mΩ ~ 900mΩ
WW08G			±100		21mΩ ~ 900mΩ
WW06F	0603 (1608)	1/8W	±75	±0.5%, ±1%	101mΩ ~ 900mΩ
WW06G			±100		21mΩ ~ 900mΩ
WW04F	0402 (1005)	1/10W	±75	±0.5%, ±1%	101mΩ ~ 900mΩ
WW04G			±100		21mΩ ~ 900mΩ

■ Thin Film Foil Current Sensor (High power, Low TCR)

Series	Size	Rated Power	TCR (ppm/°C)	Tolerance	Resistance
TTL25P	2512 (6432)	1W	±50, ±100	±0.5%, ±1%	2~100 mΩ (TCR100) 10~100mΩ
TTL25O		2W			
TTL12M	1206 (3216)	1/2W	±50, ±75, ±100	±0.5%, ±1%	1mΩ ~ 100mΩ
TTL12P		1W			
TTL08J	0805 (2012)	1/4W	±75	±0.5%(>10mΩ), ±1%,±5%	5mΩ ~ 20mΩ
TTL08K		1/3W			
TTL08M		1/2W			
TTL06I	0603 (1608)	1/5W	±150, ±75	±0.5%(>10mΩ), ±1%,±5%	5mΩ ~ 20mΩ
TTL06J		1/4W			
TTL06K		1/3W			
TTL06M		1/2W			
TTL04J	0402 (1005)	1/4W	±150,±100	±1%	2.5mΩ(TCR150)
TTL04K		1/3W			5 ~ 20mΩ (TCR100)
TTL04M		1/2W			
TTL02I		1/5W			
TTL02J		1/4W			
TTL02K		1/3W			

■ **General Purpose Chip Resistors (1Ω~10MΩ)**

■ **Feature**

1. High reliability and stability
2. Reduced size of final equipment
3. Lower assembly costs
4. Higher component and equipment reliability
5. RoHs compliant and lead free products

■ **Application**

1. Consumer electrical equipment, PDA Digital Camcorder, ...
2. EDP, Computer application
3. Mobile phone, Telecom
4. Power supply, Battery charger, DC-DC power converter
5. Digital meter
6. Automotives

■ **Description**

The resistors are constructed in a high grade ceramic body (aluminum oxide). Internal metal electrodes are added at each end and connected by a resistive paste that is applied to the top surface of the substrate. The composition of the paste is adjusted to give the approximate resistance required and the value is trimmed to within tolerance by laser cutting of this resistive layer.

The resistive layer is covered with a protective coat. Finally, the two external end terminations are added. For ease of soldering the outer layer of these end terminations is Tin solder (Pb free) alloy.

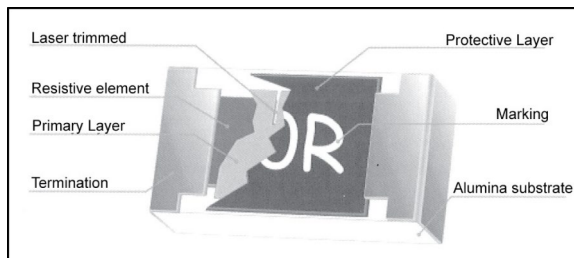

■ **Quick Reference Data**

Series No.	WR25X	WR20X	WR18X	WR10X	WR12X	WR08X	WR06X	WR04X	WR02X	WR01X
Size code	2512 (6432)	2010 (5025)	1218(3248)	1210 (3225)	1206 (3216)	0805(2012)	0603(1608)	0402(1005)	0201(0603)	01005(0402)
Resistance Range ±5% Tolerance (E24) ±1% Tolerance (E24+E96)	±5% (E24): 1Ω~10MΩ; Jumper ±1% (E2+E964): 1Ω~10MΩ									
TCR (ppm/°C) R>1MΩ 1MΩ≥R>10Ω R≤10Ω	≤±200 ≤±100 ≤±200		≤±200 ≤±100 ≤±200		≤±100 ≤±100 -200 ~ +400			≤±200 ≤±300		≤±200 ≤±300
Max. dissipation @ Tamb=70°C	1.0 W	3/4 W	1.0 W	1/3 W	1/4 W	1/8 W	1/10 W	1/16 W	1/20 W	1/32 W
Max. Operation Voltage (DC or RMS)	250V	200V	200V	200V	200V	150V	75V	50V	25V	20V
Operating Temperature	-55 ~ +155°C								-55 ~ +125°C	
Basic Specification	JIS C 5201-1 / IEC 60115-1									

Note:

1. This is the maximum voltage that may be continuously supplied to the resistor element, see "IEC publication 60115-8".
2. Max. Operation Voltage: So called RCWW (Rated Continuous Working Voltage) is determined by  $RCWV = \sqrt{\text{Rated Power} \times \text{Resistance Value}}$  or Max. RCWV listed above, whichever is lower.
3. Detailed TCR please refer to specific specification.

■ **Quick Reference Data**

Unit: mm

Size	2512 (6432)	2010 (5025)	1218 (3248)	1210 (3225)	1206 (3216)	0805 (2012)	0603 (1608)	0402 (1005)	0201 (0603)	01005 (0402)
L	6.40±0.20	5.00±0.20	3.05±0.15	3.10±0.10	3.10±0.10	2.00±0.10	1.60±0.10	1.00±0.05	0.60±0.03	0.40±0.02
W	3.20±0.20	2.50±0.20	4.60±0.20	2.60±0.10	1.60±0.10	1.25±0.10	0.80±0.10	0.50±0.05	0.30±0.03	0.20±0.02
T	0.60±0.10	0.55±0.10	0.55±0.10	0.55±0.10	0.60±0.15	0.50±0.15	0.45±0.15	0.35±0.05	0.23±0.03	0.13±0.02
Tb	0.90±0.25	0.60±0.25	0.50±0.25	0.50±0.20	0.45±0.20	0.40±0.20	0.30±0.15	0.25±0.10	0.15±0.05	0.10±0.03
Tt	0.65±0.25	0.65±0.25	0.45±0.25	0.50±0.20	0.50±0.20	0.40±0.20	0.30±0.10	0.20±0.10	0.10±0.05	0.08±0.03

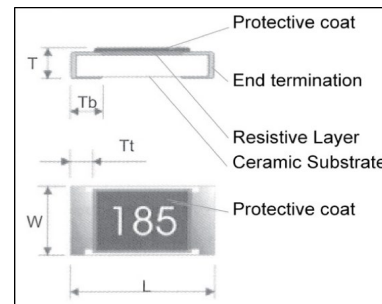

■ **Power Deration Curve**

For resistors operated in ambient temperature over 70°C, power rating should be derated in accordance with the following figures.

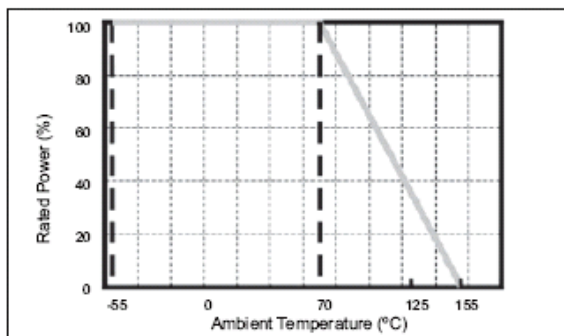

For Climatic category (IEC 60068) 55/155/56

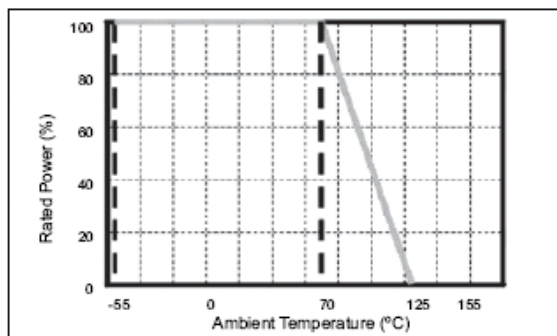

For Climatic category (IEC 60068) 55/125/56 (for 0201 type)

## Thick Film Low Ohm/Power Low Ohm Chip Resistors

### Function for Low Ohm Chip Resistor

The low ohmic resistors are used to sense output current in power supply, automotive and engine control management system, and other power sensing application. As shows in figure below, the typical function of low ohmic (power) chip resistor is to be a current sensor ( $R_{sense}$ ) to generate the sensing voltage ( $V_s$ ) for the purpose of feedback control when output current ( $I_o$ ) passed on it. The sensing voltage be treated as a signal to trigger the switches (CMOS) ON/OFF duration so that to monitor and/or adjust the output current from inductor.

Simplify to say,  $V_s = I_o \times R_{sense}$ .

In general case, this feedback voltage is setting around 100mV for considering both on power saving and noise robustness. To sense a 5 ampere average output current, the  $R_{sense}$  resistance value therefore be required as  $100mV / 5A = 20 m\Omega$ , the power dissipation will be :

$$P = I^2 \times R = 5A^2 \times 20m\Omega = 0.5Watt$$

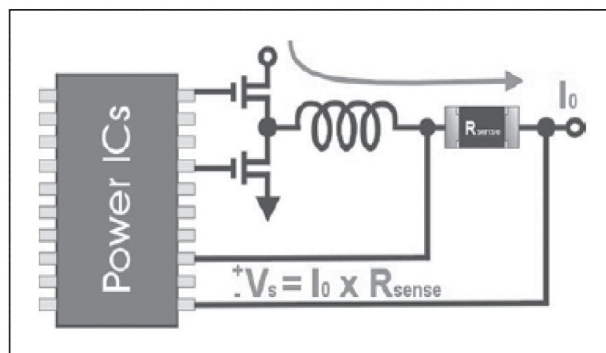

### Quick Reference Data of Low Ohm Chip Resistor

Series No.	WW25X	WW20X	WW18X	WW10X	WW12X	WW08X	WW06X	WW04X
Size code	2512 (6432)	2010 (5025)	1218(3248)	1210 (3225)	1206 (3216)	0805(2012)	0603(1608)	0402(1005)
Resistance Tolerance	±5% , ±1%							
Resistance Range	0.020Ω ~ 0.976Ω						0.100Ω ~ 0.976Ω	
TCR (ppm/°C)	Detailed TCR please refer to specific data sheets							
Max. dissipation @ Tamb=70°C	1 Watt	0.5 Watt	1 Watt	1/3 Watt	1/4 Watt	1/8 Watt	1/10 Watt	1/16 Watt
Max. Operation Voltage (DC or RMS)	250V	200V	200V	200V	200V	100V	50V	50V
Operating Temperature	-55 ~ +155°C							
Basic Specification	JIS C 5201-1 / IEC 60115-1							

Note:

1. This is the maximum voltage that may be continuously supplied to the resistor element, see "IEC publication 60115-9".
2. Power derating curve, and detail specification please refer to specific data sheets.
3. Resistance value will be changed by soldering condition and design of soldering pad, please design products in consideration of change of resistance value.

### Quick Reference Data of Power Low Ohm Chip Resistor

Item	General Specification					
Series No.	WW25P	WW20P	WW12P	WW08P	WW06P	WW04P
Size code	2512 (6432)	2010 (5025)	1206 (3216)	0805(2012)	0603(1608)	0402(1005)
Resistance Tolerance	±5% , ±1%					
Resistance Range	0.047Ω ~ 0.976Ω					0.1Ω~0.976Ω
TCR (ppm/°C) < 0.100Ω	±150ppm/°C	±150ppm/°C	±200ppm/°C	±200ppm/°C	±250ppm/°C	-
≥ 0.100Ω	±100ppm/°C	±100ppm/°C	±100ppm/°C	±150ppm/°C	±200ppm/°C	0~+300ppm/°C
Max. dissipation @ Tamb=70°C	2 W	1 W	1/2 W	1/3 W	1/4 W	1/8 W
Max. Operation Voltage (DC or RMS)	300V	200V	200V	150V	50V	50V
Operating Temperature	-55 ~ +155°C					

Note:

1. This is the maximum voltage that may be continuously supplied to the resistor element, see "IEC publication 60115-8".
2. Max. Operation Voltage: So called RCWW (Rated Continuous Working Voltage) is determined by  $RCWW = \sqrt{\text{Rated Power} \times \text{Resistance Value}}$  or Max. RCWW listed above, whichever is lower.
3. 2W loading with total solder-pad and trace size of 300mm<sup>2</sup>

### Physical Dimensions

Unit: mm

Dimensions	WW25P	WW20P	WW12P	WW08P	WW06P	WW04P
L	6.30±0.20	5.00±0.20	3.10±0.15	2.00±0.15	1.60±0.10	1.00±0.05
W	3.10±0.20	2.50±0.20	1.60±0.15	1.20±0.15	0.80±0.10	0.50±0.05
T	0.60±0.15	0.60±0.10	0.55±0.10	0.50±0.10	0.45±0.10	0.35±0.05
Tt	0.60±0.25	0.60±0.25	0.50±0.25	0.40±0.20	0.30±0.20	0.20±0.10
Tb	1.80±0.25	0.65±0.25	0.50±0.25	0.40±0.20	0.30±0.20	0.25±0.05/-0.1

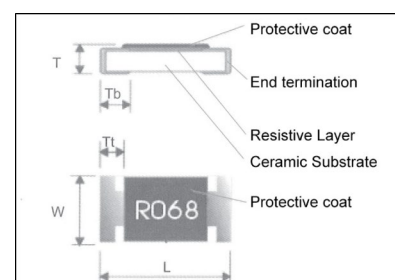

■ Metal Low Ohm Sensing Chip Resistors (0.001Ω~ 0.100Ω)

■ Description

The resistors are constructed in a high grade low resistive metal body. The resistive layer is covered with a protective coat and printed a resistance marking code over it. Finally, the two external end terminations are added. For ease of soldering, the outer layers of these end terminations are lead free terminations.

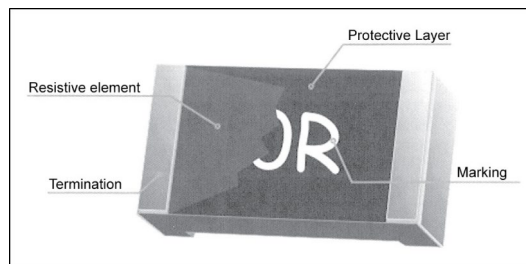

■ Quick Reference Data

Item	General Specification						
Series No.	WW25R	WW25Q	WW12R	WW12D	WW08R	WW08D	WW06R
Size code	2512 (6432)		1206(3216)		0805 (2012)	0805 (2012)	0603 (1608)
Resistance Tolerance	±5% , ±1%						
Resistance Range (mΩ)	1 ~ 10	1 ~ 15	1 ~15	20, 25, 30, 40, 50	2 ~ 10	20, 25, 30, 40, 50	5, 10
TCR (ppm/°C)	±100		±75		±75	±75	±75
Max. dissipation @ Tamb=70°C	2 W	1 W	1 W	1 W	1/2 W	1/2 W	1/3 W
Operating Temperature	-55 ~ +155°C						

Item	General Specification							
Series No.	WW25A	WW25B	WW25N	WW25M	WW20M	WW20N	WW12M	WW12N
Size code	2512 (6432)				2010 (5025)		1206(3216)	
Resistance Tolerance	±5% , ±1%							
Resistance Range (mΩ)	5, 6, 7, 8, 9, 10, 12, 15 18, 20, 25, 30, 33, 35, 40, 50	3, 4, 5, 6, 7, 8, 9, 10, 20	3, 4, 5, 6, 7, 8, 9, 10, 12,15, 20, 25, 30, 33, 35, 40, 50, 70, 75, 80, 100		5, 10, 15, 20	5, 10, 15, 20, 25	5, 10, 15, 20	5, 10, 15, 20, 25, 30
TCR (ppm/°C)	± 70/ ± 50		± 70		± 70		± 70	
Max. dissipation @ Tamb=70°C	3W		2W	1W	1/2 W	1 W	1/2 W	1W
Operating Temperature	-55 ~ +155°C							

- Note:
1. This is the maximum voltage that may be continuously supplied to the resistor element, see "IEC publication 60115-8".
  2. Power derating curve, and detail specification please refer to specific data sheets.
  3. Resistance value will be changed by soldering condition and design of soldering pad, please design products in consideration of change of resistance value.

■ Physical Dimensions

Unit: mm

Symbol	WW25N/ WW25M	WW20N/ WW20M	WW12N/ WW12M
L	6.20±0.20	5.00±0.20	3.10±0.20
W	3.20±0.20	2.50±0.20	1.60±0.20
T	0.60±0.20	0.60±0.15	0.60±0.25
Tt	0.80±0.20	0.65±0.25	0.60±0.20
Tb	0.80±0.20	0.65±0.25	0.60±0.20

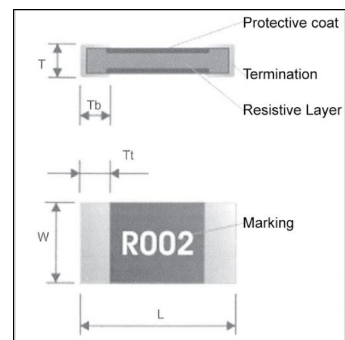

WW25Q, WW25R, WW12R, WW12D, WW06R

- Note:
1. The detailed dimensions please refer to data sheet per type.

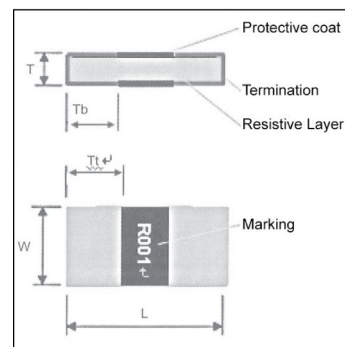



■ **Chip Resistors Array : Convex Termination**

■ **Feature**

1. High reliability and stability
2. Reduced size of final equipment
3. Lower assembly cost and higher surface mounted efficiency
4. Higher component and equipment reliability

■ **Application**

1. Consumer electrical equipment, PDA Digital Camcorder, ...
2. EDP, Computer application
3. Mobile phone, Telecom
4. DIMM

■ **Description**

The resistors array is constructed in a high grade ceramic body (aluminum oxide). Internal metal electrodes are added at each end and connected by a resistive paste that is applied to the top surface of the substrate. The composition of the paste is adjusted to give the approximate resistance required and the value is trimmed to within tolerance by laser cutting of this resistive layer.

The resistive layer is covered with a protective coat. Finally, the two external end terminations are added. For ease of soldering the outer layer of these end terminations are Tin solder alloy. Marking code description is depended on component size and tolerance. Following figure shown the construction of a Chip-R array..

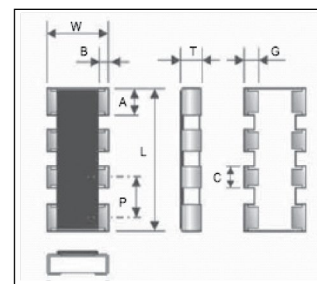
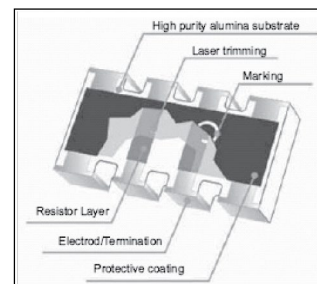

■ **Physical Dimensions**

Unit: mm

Type	WA06X	WA04X	WA06Y	WA04Y
L	3.20±0.10	2.00±0.10	1.60±0.10	1.00±0.10
W	1.60±0.10	1.00±0.10	1.50±0.10	1.00±0.10
T	0.50±0.10	0.45±0.10	0.50±0.10	0.35±0.10
P	0.80±0.10	0.50±0.05	1.00±0.10	0.65±0.10
A	0.60±0.10	0.40±0.10	0.60±0.10	0.34±0.10
B	0.30±0.10	0.20±0.10	0.30±0.15	0.20±0.15
C	0.40±0.10	0.30±0.05	-	-
G	0.30±0.20	0.25±0.10	0.30±0.15	0.25±0.17

■ **Quick Reference Data**

Series No.	WA06X	WA04X	WA06Y	WA04Y
Size	0603×4(1608×4)	0402×4(1005×4)	0603×2(1608×4)	0402×2(1005×2)
Termination construction	8P4R,Convex		4P2R,Convex	
Resistance Tolerance	±5%, ±1% (E24 series)			
Resistance Range	10Ω~1MΩ(E24 series), Jumper (0Ω)			
TCR (ppm/°C)	±200 ppm/°C			
Max. dissipation @ Tamb=70°C	1/10 Watt	1/16 Watt	1/10 Watt	1/16 Watt
Max. Operation Voltage (DC or RMS)	50V	50V	50V	25V
Max. Overload Voltage (DC or RMS)	100V	100V	100V	50V
Operating Temperature	-55 ~ +155°C			
Basic Specification	JIS C5201-1 / IEC 60115-1			
Circuit Mode: R1=R2(=R3=R4)				

Note:

1. Power derating curve and detail specification please refer to specific data sheets.

■ **WA06W Chip Resistors Array 16P8R**

■ **Description**

The resistors array is constructed in a high grade ceramic body (aluminum oxide). Internal metal electrodes are added at each end and connected by a resistive paste that is applied to the top surface of the substrate. The composition of the paste is adjusted to give the approximate resistance required and the value is trimmed to within tolerance by laser cutting of this resistive layer.

The resistors layer is covered with a protective coat. Finally, the two external end terminations are added. For ease of soldering the outer layer of these end termination is Tin (Pb free) solder alloy.

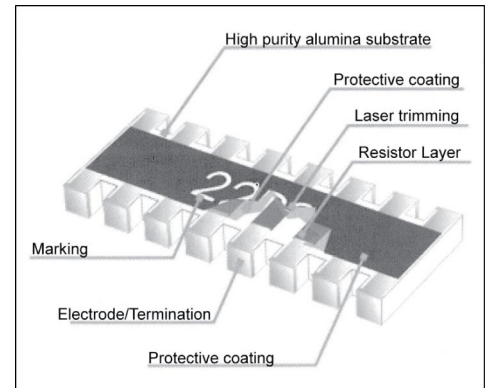

■ **Quick Reference Data**

Item	General Specification	
Series No.	WA06W	WA06W_N
Size	1606 (0402×8)	1506 (0402×8)
Termination construction	Convex type	Convex type
Resistance Tolerance	±5% (E24 series)	±5% (E24 series)
Resistance Range	10Ω~100KΩ, Jumper (0Ω)	10Ω~100KΩ, Jumper (0Ω)
TCR (ppm/°C)	± 200 ppm/°C	± 200 ppm/°C
Max. dissipation @ Tamb=70°C	1/16 W	1/16 W
Max. Operation Voltage (DC or RMS)	50V	25V
Max. Overload Voltage (DC or RMS)	100V	50V
carrier Tape width	12 mm	8 mm
Operating Temperature	-55 ~ +155°C	
Circuit Mode: R1=R2=R3=R4=R5=R6=R7=R8		

Note:

1. Power derating curve and detail specification please refer to specific data sheets.

■ **Physical Dimensions**

Unit: mm

Symbol	WA06W	WA06W_N
L	4.00±0.20	3.80±0.10
W	1.60±0.15	1.60±0.10
T	0.45±0.10	0.45±0.10
B	0.30±0.20	0.30±0.10
G	0.30±0.20	0.30±0.10
D	0.20±0.10	0.20±0.10
P	0.50±0.20	0.50±0.10
H1	0.40±0.20	0.30±0.10
H2	0.30±0.10	0.30±0.10

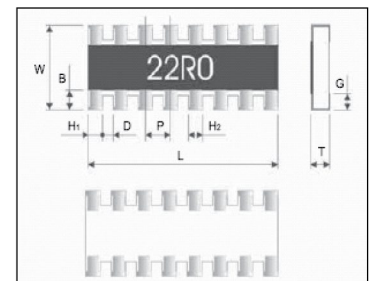

■ **Chip Resistors Array : Concave Termination**

■ **Feature**

1. High reliability and stability
2. Reduced size of final equipment
3. Lower assembly cost and higher surface mounted efficiency
4. Higher component and equipment reliability
5. Strong body and terminations
6. Excellent performance in surface mounting assembly.

■ **Application**

1. Consumer electrical equipment, PDA Digital Camcorder,
2. EDP, Computer application
3. Mobile phone, Telecom
4. DIMM

■ **Description and Physical Dimensions**

The resistor array is constructed in a high grade ceramic body (aluminum oxide). Internal metal electrodes are added at each end and connected by a resistive paste that is applied to the top surface of the substrate. The composition of the paste is adjusted to give the approximate resistance required and the value is trimmed to within tolerance by laser cutting of this resistive layer.

The resistive layer is covered with a protective coat. Finally, the two external end terminations are added. For ease of soldering the outer layer of these ends termination is Tin solder alloy. Marking code description is depended on component size and tolerance. Following figure shown the construction of a Chip-R array.

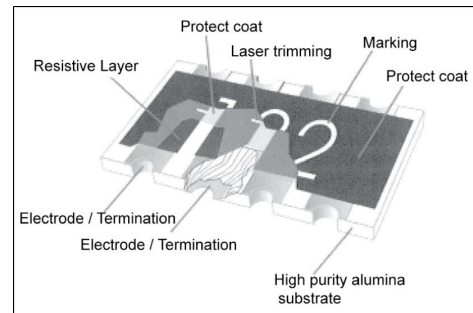

■ **Quick Reference Data**

Item	General Specification			
Series No.	WA06T	WA04T	WA04U	
Size	0603×4 (1608×4)	0402×4 (1005×4)	0402×2 (1005×2)	
Termination construction	Concave type			
Resistance Tolerance	±5% , ±1% (E24 series)			
Resistance Range	10Ω~1MΩ, Jumper (0Ω)			
TCR (ppm/°C)	± 200 ppm/°C	± 300 ppm/°C	± 300 ppm/°C	
Max. dissipation @ Tamb=70°C	1/10 W	1/16 W	1/16 W	
Max. Operation Voltage (DC or RMS)	50V	25V	25V	
Max. Overload Voltage	100V	50V	50V	
Operating Temperature	-55 ~ +155°C			
Circuit Mode	<p>R1=R2=R3=R4</p>		<p>R1 = R2</p>	
	L	3.20+0.20/-0.10mm	2.00±0.10mm	1.00±0.10mm
	W	1.60+0.20/-0.10mm	1.00±0.10mm	1.00±0.10mm
	T	0.60±0.20mm	0.45±0.10mm	0.30±0.10mm
	P	0.80±0.10mm	0.50±0.05mm	0.50±0.05mm
	A	0.60±0.15mm	0.35±0.05mm	0.35±0.10mm
	B	0.35±0.15mm	0.20±0.15mm	0.25±0.15mm
	C	0.50±0.15mm	0.25±0.05mm	0.35±0.10mm
	G	0.50±0.15mm	0.25±0.15mm	0.25±0.15mm

Note:

1. Power derating curve and detail specification please refer to specific data sheets.
2. Max. Operation Voltage: So called RCWW (Rated Continuous Working Voltage) is determined by  
 $RCWW = \sqrt{\text{Rater Power} \times \text{Resistance Value}}$  or Max. RCWW listed above, whichever is lower.

■ **High Precision Thin Film Chip Resistors Array : Convex Termination**

■ **Feature**

1. SMD metal film resistor
2. High reliability and stability of 0.1% and below per customer request
3. Low current noise
4. +/-0.02% is upon the customer request
5. TCR tracking down to 5 ppm/°C
6. Tolerance tracking down to 0.05%
7. AEC-Q200 compliant

■ **Application**

1. Medical equipment
2. Measuring instrument
3. Communication device
4. Computer.

■ **Description**

The resistors are constructed in a high grade ceramic body (aluminum oxide). Internal metal electrodes are added at each end and connected by a resistive layer that is applied to the top surface of the substrate. The composition of the resistive layer is adjusted to give the approximate resistance required and the value is trimmed to nominated value within tolerance which controlled by laser trimming of this resistive layer.

The resistive layer is covered with a protective coat. Finally, the two external end terminations are added. For environmental soldering issue, the outer layer of these end terminations is a Lead-free solder.

■ **Physical Dimensions**

Unit: mm

Type	TA06N/TA06M
W	1.50±0.15
L	3.20±0.15
P	0.80±0.10
C	0.40±0.10
A	0.60±0.10
B	0.40±0.15
G	0.30±0.15
T	0.40±0.04

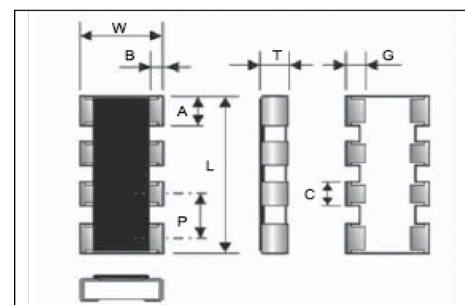
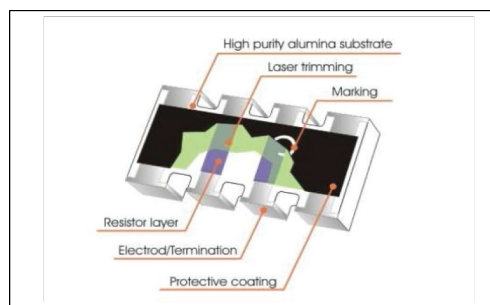

■ **Quick Reference Data**

Series No.	TA06N	TA06M
Size	0603×4	
Termination construction	Convex	
Resistance Tolerance	±1%, ±0.5%, ±0.25%, ±0.1% (E24+E96 series)	
Resistance Range	20R ~ 200KΩ	
TCR (ppm/°C)	±25 ppm/°C	±50 ppm/°C
Max. dissipation at Tamb=70°C	0.1watts / element @70°C 0.4watts / package @70°C	
Max. Operating Voltage (DC or RMS)	75V	
Max. Overload Voltage (DC or RMS)	150V	
Operating Temperature	-55 ~ +155°C	
Basic Specification	JIS C5201-1 / IEC 60115-8	
Circuit Mode: R1=R2(=R3=R4)		

Note:

1. Power derating curve and detail specification please refer to specific data sheets.

■ **WT04X Chip Resistor Network 10P8R**

■ **Description**

The resistor array is constructed in a high grade ceramic body (aluminum oxide). Internal metal electrodes are added at each end and connected by a resistive paste that is applied to the top surface of the substrate. The composition of the paste is adjusted to give the approximate resistance required and the value is trimmed to within tolerance by laser cutting of this resistive layer.

The resistive layer is covered with a protective coat. Finally, the two external end terminations are added. For ease of soldering the outer layer of these end termination is Tin (Pb free) solder alloy.

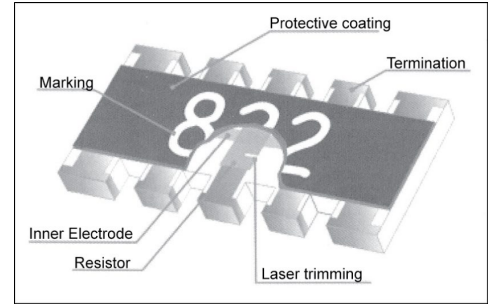

■ **Quick Reference Data**

Item	General Specification
Series No.	WT04X
Size	0402x8 (1005x8)
Termination construction	Convex type
Resistance Tolerance	±5% (E24 series)
Resistance Range	10Ω ~ 100KΩ
TCR (ppm/°C)	± 200 ppm/°C
Max. dissipation @ Tamb=70°C	1/16 W
Max. Operation Voltage (DC or RMS)	25V
Max. Overload Voltage (DC or RMS)	50V
Operating Temperature	-55 ~ +155°C
Circuit Mode: Resistor elements on pin1 ~ pin4, pin6 ~ pin9; R1=R2=R3=R4=R6=R7=R8=R9	

Note:

1. Power derating curve and detail specification please refer to specific data sheets.

■ **Physical Dimensions**

Unit: mm

Symbol	
L	3.30±0.20
W	1.60±0.15
T	0.55±0.10
P	0.64±0.05
A	0.50±0.05
B	0.40±0.15
C	0.40±0.15
G	0.40±0.15

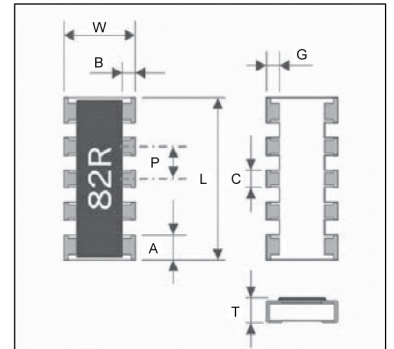

■ **WA04P Chip Attenuator**

■ **Typical Application of Chip Attenuator**

WA04	P	001	X	B	T	L
Size code	Type code	Attenuation Range	Characteristic Impedance	Attenuation Tolerance	Termination	Packaging
WA04: 0402 per element	P:convex, p type attenuator	000 = 0dB R05 = 0.5dB 001 = 1dB R15 = 1.5dB 002 = 2dB 003 = 3dB 004 = 4dB 005 = 5dB 006 = 6dB 007 = 7dB 008 = 8dB 009 = 9dB 010 = 10dB 011 = 11dB 012 = 12dB 013 = 13dB 014 = 14dB 015 = 15dB 016 = 16dB 017 = 17dB 018 = 18dB 019 = 19dB 020 = 20dB	X:50Ω	A : ± 0.1dB B : ± 0.3dB C : ± 0.4dB D : ± 0.8dB E : ± 1.0dB F : ± 1.5dB G : ± 2.0dB H : ± 2.5dB P : -	T=7" reel taped	L=Sn base (lead free)

π type Attenuator for VSWR improvement and output frequency level matching on VCO application.

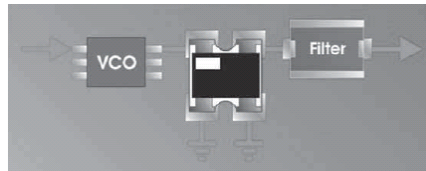

■ **Quick Reference Data**

Item	General Specification
Series No.	WA04P
Size	0402×2 (1005×2)
Termination construction	Convex type
Attenuation Range	0dB, 0.5dB ~ 20dB
Attenuation Tolerance	
0dB	-
0.5 dB	±0.1dB
1dB ~ 5dB	±0.3dB
6dB ~ 10dB	±0.4dB
11dB ~ 13dB	±0.8dB
14dB	±1.0dB
15 ~ 16dB	±1.5dB
17 ~ 19dB	±2.0dB
20dB	±2.5dB
Characteristic impedance	50Ω
Rated power at Tamb=70°C	0.1 W / package
Limiting Voltage (DC)	50V
Frequency range (DC)	MAX. 3 GHz
VSWR (Voltage Standing Wave Ratio)	MAX. 1.2
Number of Resistors	3 resistors
Number of Terminals	4 terminals
Operating Temperature	-40 ~ +125°C

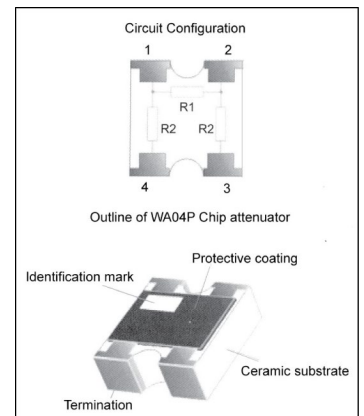
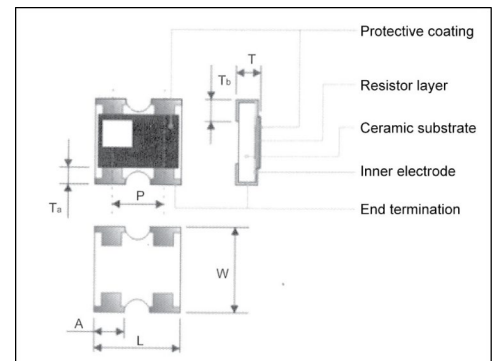

■ **Physical Dimensions**

Unit: mm

	WA04P
L	1.00±0.10
W	1.00+0.10/-0
T	0.35±0.10
P	0.65±0.20
A	0.33±0.10
Ta	0.15±0.10
Tb	0.25±0.10

■ **Special Application Chip Resistors**

■ **Feature**

1. Provided Automotive & Anti-sulfuration resistors (MR/SR series) for Auto & Anti-sulfuration application.
2. Provided Total Lead Free resistors (WR\_R series) to fulfill RoHS environmental regulation.
3. Provided trimmable resistors (WKxxM series) for customer special tolerance requirement.
4. Provided high precision tolerance (WFxxH/ WFxxT/ WFxxU/ WFxxW) down to  $\pm 0.05\%$  and TCR down to 10ppm/°C for voltage sensing application.
5. High reliability and stability.
6. Reduced size of final equipment
7. Lower assembly costs.
8. Higher component and equipment reliability
9. Special resistance, tolerances are available upon customer's request.

■ **MR Series of Automotive & SR Series of Anti-sulfuration Chip Resistor**

■ **Feature**

1. High reliability and stability  $\pm 1\%$ .
2. Sulfuration resistant
3. Automotive grade AEC Q-200 compliant.
4. 100% CCD inspection.
5. RoHS compliant and lead free.

■ **Application**

1. Automotive application.
2. Consumer electrical equipment.
3. EDP, Computer application.
4. Telecom Application.

■ **Quick Reference Data**

Series No.	MR25X	MR20X	MR18X	MR10X	MR12X	MR08X	MR06X	MR04X
Size code	2512(6432)	2010(5025)	1218(3248)	1210(3225)	1206(3126)	0805(2012)	0603(1608)	0402(1005)
Resistance Range	1Ω~10MΩ ( $\pm 1\%$ , $\pm 5\%$ ), Jumper				1Ω~10MΩ ( $\pm 1\%$ , $\pm 5\%$ ), Jumper			
TCR (ppm/°C)	$\pm 200$ ppm*				$\pm 200$ ppm*			
Max. dissipation @ Tamb=70°C	1 W	3/4 W	1 W	1/2 W	1/4 W	1/4 W	1/8 W	1/10 W
Max. Operation Voltage	250V	200V	200V	200V	200V	150V	75V	50V
Operating Temperature	-55 ~ +155°C				-55 ~ +155°C			

Series No.	SR25X	SR20X	SR12X	SR08X	SR06X	SR04X
Size code	2512(6432)	2010(5025)	1206(3126)	0805(2012)	0603(1608)	0402(1005)
Resistance Range	1Ω~10MΩ ( $\pm 1\%$ , $\pm 5\%$ ), Jumper					
TCR (ppm/°C)	$\pm 200$ ppm*					
Max. dissipation @ Tamb=70°C	1 W	3/4 W	1/4 W	1/4 W	1/8 W	1/10 W
Max. Operation Voltage	250V	200V	200V	150V	75V	50V
Operating Temperature	-55 ~ +155°C					

Remark: \*Detail specification please refers to specific data sheets. \*MR series can withstand H2S 3ppm×1000hrs. \*SR series can withstand H2S 1000ppm×720hrs.

■ **WR\_R Series of Total Lead Free Chip Resistor**

■ **Feature**

1. High reliability and stability
2. Reduced size of final equipment
3. Lower assembly cost
4. Higher component and equipment reliability
5. RoHS compliant and total lead free.

■ **Quick Reference Data**

Series No.	WR25_R	WR18_R	WR20_R	WR10_R	WR12_R	WR08_R	WR06_R	WR04_R	WR02_R
Size code	2512 (6432)	1218 (3248)	2010(5025)	1210 (3225)	1206 (3216)	0805 (2012)	0603 (1608)	0402 (1005)	0201 (0603)
Resistance Range	1Ω~10MΩ ( $\pm 1\%$ , $\pm 5\%$ ), Jumper								
TCR (ppm/°C)	$\pm 200$ ppm*								
Max. dissipation @ Tamb=70°C	1 W	1W	1/2W	1/3W	1/4 W	1/8 W	1/10 W	1/16 W	1/20 W
Max. Operation Voltage	250V	200V	200V	200V	200V	150V	50V	50V	25V
Operating Temperature	-55 ~ +155°C								-55 ~ +125°C

Remark: \*Detail specification please refers to specific data sheets.

■ **Part No. Definition**

1 <sup>st</sup> code	2 <sup>nd</sup> code	3 <sup>rd</sup> - 4 <sup>th</sup> code	5 <sup>th</sup> code	6 <sup>th</sup> - 9 <sup>th</sup> code	10 <sup>th</sup> code	11 <sup>th</sup> code	12 <sup>th</sup> code
□	□	□□	□	□□□□	□	□	<u>R</u>
WTC	Type code	Size code	Functional code	Marking code (Resistance)	Tolerance code	Packaging code	Termination code
For example:							
W	R	04	X	1000	F	T	R

■ **WKxxM Series of Trimmable Chip Resistor**

■ **Feature**

1. High precision, reliability and stability
2. Miniature size down to 0603 (1608)

■ **Application**

1. Automotive application.
2. Consumer electrical equipment.
3. EDP, Computer application.
4. Telecom Application.

■ **Description**

The resistors are constructed on a high grade ceramic body (aluminum oxide). Internal metal electrodes are added at each end and connected by a resistive paste that is applied to the top surface of the substrate. The composition of the paste is adjusted to give the approximate resistance required. The resistive layer is covered with a transparent protective coat. Finally, the two external end terminations are added. For ease of soldering the outer layer of these end termination is Tin (Pb free) solder alloy.

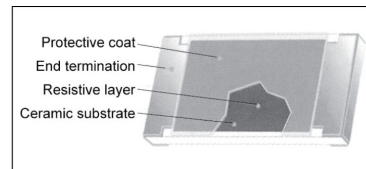

■ **Physical Dimensions**

Unit: mm

Type	WK25M	WK20M	WK10M	WK12M	WK08M	WK06M
L	6.30±0.15	5.00±0.15	3.10±0.15	3.10±0.15	2.00±0.10	1.60±0.10
W	3.20±0.15	2.50±0.15	2.50±0.15	1.60±0.15	1.25±0.10	0.80+0.15/-0.10
T	0.55±0.15	0.55±0.15	0.55±0.15	0.55±0.10	0.55±0.10	0.45±0.10
Tb	0.60±0.20	0.60±0.20	0.50±0.25	0.50±0.25	0.40±0.20	0.30±0.10
Tt	0.60±0.20	0.60±0.20	0.50±0.25	0.50±0.25	0.40±0.20	0.30±0.10

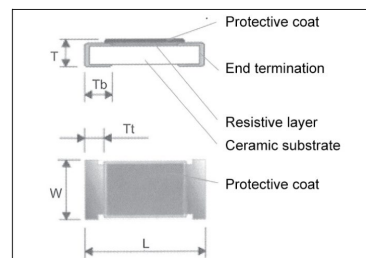

■ **Quick Reference Data**

Series No.	WK25M	WK20M	WK10M	WK12M	WK08M	WK06M
Size code	2512 (6332)	2010 (5025)	1210(3225)	1206(3216)	0805(2012)	0603(1608)
Resistance Tolerance	0/-20%(Y) and 0/-30%(X) E24 series					
Resistance Range	1Ω ~ 4.7MΩ					10Ω ~ 4.7MΩ
TCR (ppm/°C)	10Ω ~ 4.7MΩ: ±200 ppm/°C 1Ω ~ 9.1Ω: -200 ~ +500 ppm/°C					±200 ppm/°C
Max. dissipation @ Tamb=70°C	1 W	1/2 W	1/4 W	1/8 W	1/10 W	1/16 W
Max. Operation Voltage (DC or RMS)	200V	200V	200V	200V	150V	50V
Operating Temperature	-55 ~ +125°C					
Basic Specification	JIS C 5201-1 / IEC 60115-1					

■ **WKxxV Series of High Voltage Chip Resistor**

■ **Feature**

1. Special material and design for high working voltage required
2. Compatible with flow and reflow soldering.
3. Suitable for lead free soldering.

■ **Application**

1. Power supply.
2. Automotive industry.
3. Measurement instrument.
4. Back light inverter.
5. Medical or Military equipment

■ **Quick Reference Data**

Series No.	WK25N	WK20N	WK25V	WK20V	WK12V	WK08V	WK06V
Size code	2512 (6332)	2010 (5025)	2512 (6332)	2010 (5025)	1206(3216)	0805(2012)	0603(1608)
Resistance Tolerance	±5% ; ±10%		±5% ; ±1%				
Resistance Range	4.7MΩ ~ 16MΩ	1MΩ ~ 16MΩ	47Ω ~ 51MΩ				47Ω ~ 10MΩ
TCR (ppm/°C)	± 200 ppm/°C * detail refer to data sheet						
Max. dissipation @ Tamb=70°C	1 W	1/2 W	1 W	1/2 W	1/4 W	1/8 W	1/10 W
Max. Operation Voltage (DC or RMS)	2000V	1500V	800V	500V	500V	400V	200V
Operating Temperature	-55 ~ +125°C						

Note:

1. This is the maximum voltage that may be continuously supplied to the resistor element, see "IEC publication 60115-8".
2. Max. Operation Voltage: So called RCWW (Rated Continuous Working Voltage) is determined by  $RCWV = \sqrt{\text{Rater Power} \times \text{Resistance Value}}$  or Max. RCWW listed above, whichever is lower.

■ **Physical Dimensions**

Unit: mm

Symbol	WK25N	WK20N	WK25V	WK20V	WK12V	WK08V	WK06V
L	6.30±0.15	5.00±0.15	6.30±0.15	5.00±0.15	3.10±0.15	2.00±0.10	1.60±0.10
W	3.20±0.15	2.50±0.15	3.20±0.15	2.50±0.15	1.60±0.15	1.25±0.10	0.80+0.15/-0.10
T	0.55±0.15	0.55±0.15	0.55±0.15	0.55±0.15	0.55±0.10	0.55±0.10	0.45±0.10
Tt	0.60±0.20	0.50±0.20	0.60±0.20	0.60±0.20	0.50±0.25	0.40±0.20	0.30±0.10
Tb	0.60±0.20	0.60±0.20	0.60±0.20	0.60±0.20	0.50±0.25	0.40±0.20	0.30±0.10

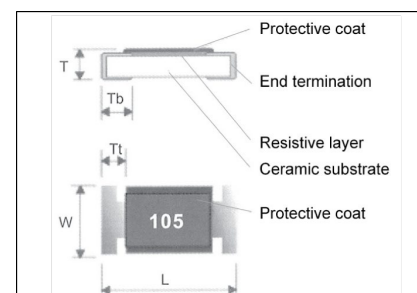



■ **WFxxP and WFxxA Series of High Power Chip Resistor**

■ **Feature**

1. High power rating and compact size
2. High reliability and stability
3. Reduced size of final equipment
4. Lead free product is upon customer requested.

■ **Application**

1. Power supply
2. PDA
3. Digital meter
4. Computer
5. Automotives.

■ **Quick Reference Data WFxxP**

Item	General Specification						
Series No.	WF25P	WF20P	WF10P	WF12P	WF08P	WF06P	WF04P
Size code	2512(6432)	2010(5025)	1210(3225)	1206(3216)	0805(2012)	0603 (1608)	0402(1005)
Resistance Tolerance	±1% , ±5%						
Resistance Range	0Ω, 1Ω ~ 1MΩ						
TCR (ppm/°C)	± 100 ppm/°C						
Max. dissipation @ Tamb=70°C	2W	1W	1/2W	1/2W	1/4W	1/8W	1/8W
Max. Operation Voltage (DC or RMS)	300V	200V	200V	200V	150V	50V	50V
Operating Temperature	-55 ~ +155°C						

Note:

1. This is the maximum voltage that may be continuously supplied to the resistor element, see "IEC publication 60115-8".
2. Max. Operation Voltage: So called RCWW (Rated Continuous Working Voltage) is determined by  $RCWW = \sqrt{\text{Rated Power} \times \text{Resistance Value}}$  or Max. RCWW listed above, whichever is lower.
3. 2W loading with total solder-pad and trace size of 300mm<sup>2</sup>
4. 0Ω maximum resistance Rmax < 15mΩ and rated current < 4Amp

■ **Physical Dimensions**

Unit: mm

Symbol	WF25P	WF20P	WF10P	WF12P	WF08P	WF06P	WF04P
L	6.30±0.20	5.00±0.20	3.10±0.10	3.10±0.15	2.00±0.15	1.60±0.10	1.00±0.05
W	3.10±0.20	2.50±0.20	2.60±0.10	1.60±0.15	1.20±0.15	0.80±0.10	0.50±0.05
T	0.60±0.15	0.60±0.10	0.55±0.10	0.55±0.10	0.50±0.10	0.45±0.10	0.35±0.05
Tt	0.60±0.25	0.60±0.25	0.50±0.20	0.50±0.25	0.40±0.20	0.30±0.20	0.25±0.10
Tb	1.80±0.25	0.60±0.25	0.50±0.20	0.50±0.25	0.40±0.20	0.30±0.20	0.25±0.10

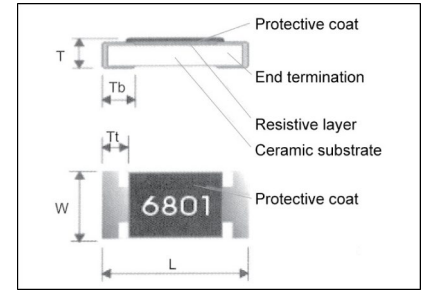

■ **Quick Reference Data WFxxA**

Item	General Specification					
Series No.	WF25A	WF20A	WF10A	WF12A	WF08A	WF06A
Size code	2512(6432)	2010(5025)	1210(3225)	1206(3216)	0805(2012)	0603 (1608)
Resistance Tolerance	±1% , ±5%					
Resistance Range	1Ω ~ 1MΩ					
TCR (ppm/°C)	± 100 ppm/°C					
Max. dissipation @ Tamb=70°C	3W	1.5W	3/4W	3/4W	1/2W	1/3W
Max. Operation Voltage (DC or RMS)	250V	200V	200V	250V	200V	75V
Operating Temperature	-55 ~ +155°C					

■ **Physical Dimensions**

Unit: mm

Symbol	WF25A	WF20A	WF10A	WF12A	WF08A	WF06A
L	6.40±0.20	5.00±0.20	3.10±0.10	3.10±0.10	2.00±0.10	1.60±0.10
W	3.10±0.20	2.50±0.20	2.60±0.10	1.60±0.10	1.20±0.10	0.80±0.10
T	1.10±0.20	0.60±0.10	0.55±0.10	0.55±0.10	0.50±0.10	0.45±0.10
Tt	0.40±0.25	0.60±0.25	0.50±0.20	0.50±0.25	0.40±0.20	0.30±0.20
Tb	1.80±0.25	0.60±0.25	0.50±0.20	0.50±0.25	0.40±0.20	0.30±0.20

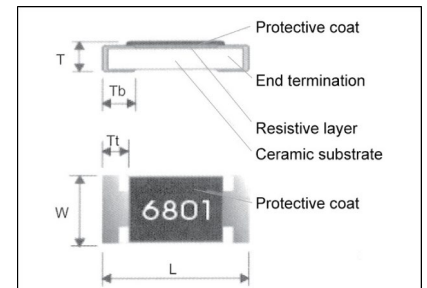

■ **WKxxS Series of Anti-Surge Chip Resistor**

■ **Feature**

1. Power rating and compact size
2. High reliability and stability
3. Reduced size of final equipment
4. Surge protection.

■ **Application**

1. Power supply.
2. Measurement instrument.
3. Automotive industry.
4. Medical or Military equipment.

■ **Quick Reference Data**

Item	General Specification				
Series No.	WK25S	WK20S	WK10S	WK12S	WK08S
Size code	2512(6432)	2010(5025)	1210(3225)	1206(3216)	0805(2012)
Resistance Tolerance	±5% , ±10% , ±20% , (E24)				
Resistance Range	0.27Ω ~ 22MΩ				
TCR (ppm/°C)	± 200 ppm/°C				
Max. dissipation @ Tamb=70°C	1 W	3/4W	1/2W	1/4W	1/8W
Max. Operation Voltage (DC or RMS)	200V				150V
Operating Temperature	-55 ~ +155°C				

Note:

1. This is the maximum voltage that may be continuously supplied to the resistor element, see "IEC publication 60115-8".
2. Max. Operation Voltage: So called RCWV (Rated Continuous Working Voltage) is determined by  $RCWV = \sqrt{\text{Rater Power} \times \text{Resistance Value}}$  or Max. RCWV listed above, whichever is lower.

■ **Physical Dimensions**

Unit: mm

Symbol	WK25S	WK20S	WK10S	WK12S	WK08S
L	6.30±0.15	5.00±0.15	3.20±0.15	3.20±0.15	2.00±0.10
W	3.20±0.15	2.50±0.15	2.50±0.15	1.60±0.15	1.25±0.10
T	0.55±0.15	0.55±0.15	0.55±0.15	0.55±0.10	0.55±0.10
Tt	0.30±0.15	0.30±0.15	0.30±0.20	0.30±0.20	0.30±0.20
Tb	0.60±0.20	0.60±0.20	0.50±0.25	0.50±0.25	0.40±0.20

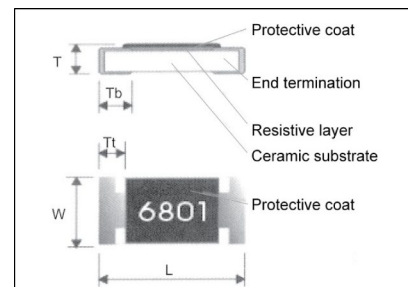
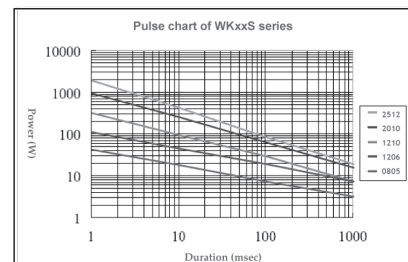

■ **Thick Film High Precision Chip Resistor**

■ **Narrow Tolerance Thick Film TC100 WFxxH Series (E96+E24 series)**

Series No.	WF12H	WF08H	WF06H	WF04H
Size	1206(3216)	0805(2012)	0603(1608)	0402(1005)
Resistance Tolerance	±0.5% , ±0.1%			
Resistance Range	10Ω ~ 1MΩ (E96+E24 series)			
TCR (ppm/°C)	±100 ppm/°C			
Max. dissipation @ Tamb=70°C	1/4 W	1/8 W	1/10 W	1/16 W
Max. Operation Voltage (DC or RMS)	200V	100V	50V	50V
Operating Temperature	-55 ~ +155°C			
Basic Specification	JIS C5201-1 / IEC 60115-1			

(Detail specification please refer to specific data sheets)

■ **Narrow Tolerance Thick Film TC50 WFxxK Series (E96+E24 series)**

Series No.	WF12K	WF08K	WF06K	WF04K
Size	1206(3216)	0805(2012)	0603(1608)	0402(1005)
Resistance Tolerance	±0.5% , ±0.1%			
Resistance Range	10Ω ~ 1MΩ (E96+E24 series)			
TCR (ppm/°C)	±50 ppm/°C			
Max. dissipation @ Tamb=70°C	1/4 W	1/8 W	1/10 W	1/16 W
Max. Operation Voltage (DC or RMS)	200V	100V	50V	50V
Operation Temperature	-55 ~ +155°C			
Basic Specification	JIS C5201-1 / IEC 60115-1			

■ **Thin Film Precision Chip Resistor: WF Series**

■ **Feature**

1. SMD metal film resistor
2. High reliability and stability of 0.25% and below per customer request
3. High performance of TCR: 50 ppm/°C and below per customer request
4. Low current noise
5. RoHS compliant and lead free

■ **Application**

1. Medical equipment
2. Measuring instrument
3. Communication device
4. Computer

■ **Thin Film TC50 / TC25 WFxxT & U Series (E192+E24 series)**

Series No.	WF25T&U	WF20T&U	WF10T&U	WF12T&U	WF08T&U	WF06T&U	WF04T&U	WF02T&U	
Size	2512(6432)	2010(5025)	1210(3225)	1206 (3216)	0805 (2012)	0603 (1608)	0402 (1005)	0201 (0603)	
Resistance Tolerance	±1%, ±0.5%, ±0.25%, ±0.1%, ±0.05%, ±0.02% ±0.01%							±1%, ±0.5%±0.1%	
Resistance Range	1~ 3MΩ	4.7~ 3MΩ	4.7~ 2.49MΩ	1~ 2.49MΩ	4.7~ 2MΩ	3.9~ 1MΩ	10~ 255KΩ	100~ 12KΩ	
TCR (ppm/°C)	±50 / 25 ppm/°C								
Max. dissipation @ Tamb=70°C	3/4W	1/2W	1/4W	1/8W	1/10W	1/16W	1/16W	1/32W	
Max. Operating Voltage (DC or RMS)	200V	200V	200V	200V	100V	50V	50V	15V	
Operating Temperature	-55 ~ +155°C								
Basic Specification	JIS C5201-1 / IEC 60115-1								

■ **Thin Film TC50 / TC25 WFxxQ & R (Power) Series (E192+E24 series)**

Series No.	WF25Q&R	WF20Q&R	WF10Q&R	WF12Q&R	WF08Q&R	WF06Q&R	WF04Q&R	WF02Q&R	
Size	2512(6432)	2010(5025)	1210(3225)	1206 (3216)	0805 (2012)	0603 (1608)	0402 (1005)	0201 (0603)	
Resistance Tolerance	±1%, ±0.5%, ±0.25%, ±0.1%, ±0.05%, ±0.02% ±0.01%							±1%, ±0.5%	
Resistance Range	1~ 3MΩ	4.7~ 3MΩ	4.7~ 2.5MΩ	1~ 2.5MΩ	4.7~ 2MΩ	3.9~ 1MΩ	10~ 255KΩ	27~ 22.1KΩ 27~ 12KΩ	
TCR (ppm/°C)	±50 / 25 ppm/°C								
Max. dissipation @ Tamb=70°C	1W	3/4W	2/5W	1/4W	1/8W	1/10W	1/10W	1/20W	
Max. Operating Voltage (DC or RMS)	200V	200V	200V	200V	150V	75V	50V	15V	
Operating Temperature	-55 ~ +155°C								
Basic Specification	JIS C5201-1 / IEC 60115-1								

■ **Thin Film TC15 / TC10 WFxxF & W Series (E192+E24 series)**

Series No.	WF25F&W	WF20F&W	WF10F&W	WF12F&W	WF08F&W	WF06F&W	WF04F&W
Size	2512(6432)	2010(5025)	1210(3225)	1206 (3216)	0805 (2012)	0603 (1608)	0402 (1005)
Resistance Tolerance	±1%, ±0.5%, ±0.25%, ±0.1%, ±0.05%, ±0.02% ±0.01%						
Resistance Range	10 ~ 1.5MΩ	10~ 1MΩ	10~ 600KΩ	4.7~ 500KΩ	4.7~ 400KΩ	4.7~ 200KΩ	10~ 100KΩ
TCR (ppm/°C)	±15 / 10 ppm/°C						
Max. dissipation @ Tamb=70°C	1W	3/4W	2/5W	1/4W	1/8W	1/10W	1/10W
Max. Operating Voltage (DC or RMS)	200V	200V	200V	200V	150V	75V	50V
Operating Temperature	-55 ~ +155°C						
Basic Specification	JIS C5201-1 / IEC 60115-1						

■ **Thin Film TC5 WFxxZ Series (E192+E24 series)**

Series No.	WF25Z	WF20Z	WF10Z	WF12Z	WF08Z	WF06Z	WF04Z
Size	2512(6432)	2010(5025)	1210(3225)	1206 (3216)	0805 (2012)	0603 (1608)	0402 (1005)
Resistance Tolerance	±1%, ±0.5%, ±0.25%, ±0.1%, ±0.05%, ±0.02% ±0.01%						
Resistance Range	4.7~ 600KΩ	4.7~ 360KΩ	4.7~ 150KΩ	4.7~ 150KΩ	4.7~ 100KΩ	4.7~ 50KΩ	10~ 10KΩ
TCR (ppm/°C)	±5 ppm/°C						
Max. dissipation @ Tamb=70°C	1W	3/4W	2/5W	1/4W	1/8W	1/10W	1/10W
Max. Operating Voltage (DC or RMS)	200V	200V	200V	200V	150V	75V	50V
Operating Temperature	-55 ~ +155°C						
Basic Specification	JIS C5201-1 / IEC 60115-1						

■ **Thin Film TC3 WFxxB Series (E192+E24 series)**

Series No.	WF25B	WF20B	WF10B	WF12B	WF08B	WF06B	WF04B
Size	2512(6432)	2010(5025)	1210(3225)	1206 (3216)	0805 (2012)	0603 (1608)	0402 (1005)
Resistance Tolerance	±1%, ±0.5%, ±0.25%, ±0.1%, ±0.05%, ±0.02% ±0.01%						
Resistance Range	4.7 ~ 600KΩ	4.7 ~ 360KΩ	4.7 ~ 150KΩ	4.7 ~ 120KΩ	4.7 ~ 80KΩ	4.7 ~ 40KΩ	10 ~ 8KΩ
TCR (ppm/°C)	±3 ppm/°C						
Max. dissipation @ Tamb=70°C	1W	3/4W	2/5W	1/4W	1/8W	1/10W	1/10W
Max. Operating Voltage (DC or RMS)	200V	200V	200V	200V	150V	75V	50V
Operating Temperature	-55 ~ +155°C						
Basic Specification	JIS C5201-1 / IEC 60115-1						

■ **Thin Film TC2 WFxxC Series (E192+E24 series)**

Series No.	WF25C	WF20C	WF10C	WF12C	WF08C	WF06C	WF04C
Size	2512(6432)	2010(5025)	1210(3225)	1206 (3216)	0805 (2012)	0603 (1608)	0402 (1005)
Resistance Tolerance	±1%, ±0.5%, ±0.25%, ±0.1%, ±0.05%, ±0.02% ±0.01%						
Resistance Range	4.7~ 600KΩ	4.7 ~ 360KΩ	4.7 ~ 150KΩ	4.7 ~ 120KΩ	4.7 ~ 80KΩ	4.7 ~ 40KΩ	10 ~ 8KΩ
TCR (ppm/°C)	±2 ppm/°C						
Max. dissipation @ Tamb=70°C	1W	3/4W	2/5W	1/4W	1/8W	1/10W	1/10W
Max. Operating Voltage (DC or RMS)	200V	200V	200V	200V	150V	75V	50V
Operating Temperature	-55 ~ +155°C						
Basic Specification	JIS C5201-1 / IEC 60115-1						

Detail specification please refer to specific data sheets

■ **High Precision Thin Film Chip Resistor (AEC-Q200 Compliant): WF\_Q Series**

■ **Feature**

1. NiCr Thin Film Resistor.
2. AEC-Q200 compliant.
3. High reliability and stability of 0.3%
4. TCR down to 5ppm/°C and below per Customer Request.
5. Tight Tolerance : 0.01%
6. Low current noise
7. RoHS compliant and lead free.

■ **Application**

1. Medical equipment
2. Measuring instrument
3. Communication device
4. Electronic Energy Meter
5. Audio System.

■ **High Precision Thin Film (AEC-Q200 Compliant) TC50 / 25 WFxxT & U\_Q Series (E192+E24 series)**

Series No.	WF25T&U_Q	WF20T&U_Q	WF10T&U_Q	WF12T&U_Q	WF08T&U_Q	WF06T&U_Q	WF04T&U_Q
Size	2512(6432)	2010(5025)	1210(3225)	1206 (3216)	0805 (2012)	0603 (1608)	0402 (1005)
Resistance Tolerance	±1%, ±0.5%, ±0.25%, ±0.1%, ±0.05%, ±0.02%, ±0.01%						
Resistance Range	10~ 1.5MΩ	10~ 1.5MΩ	10~ 1MΩ	4.7~ 1MΩ	4.7~ 1MΩ	4.7~ 330KΩ	10~ 100KΩ
TCR (ppm/°C)	±50 / 25 ppm/°C						
Max. dissipation @ Tamb=70°C	3/4W	1/2W	1/4W	1/8W	1/10W	1/16W	1/16W
Max. Operating Voltage (DC or RMS)	200V	200V	200V	200V	100V	50V	50V
Operating Temperature	-55 ~ +155°C						
Basic Specification	JIS C5201-1 / IEC 60115-1 /AEC-Q200						

■ **High Precision Thin Film (AEC-Q200 Compliant) TC50 / 25 WFxxQ & R\_Q (Power) Series (E192+E24 series)**

Series No.	WF25Q&R_Q	WF20Q&R_Q	WF10Q&R_Q	WF12Q&R_Q	WF08Q&R_Q	WF06Q&R_Q	WF04Q&R_Q
Size	2512(6432)	2010(5025)	1210(3225)	1206 (3216)	0805 (2012)	0603 (1608)	0402 (1005)
Resistance Tolerance	±1%, ±0.5%, ±0.25%, ±0.1%, ±0.05%, ±0.02%, ±0.01%						
Resistance Range	10~ 1.5MΩ	10~ 1.5MΩ	10~ 1MΩ	4.7~ 1MΩ	4.7~ 1MΩ	4.7~ 330KΩ	10~ 100KΩ
TCR (ppm/°C)	±50 / 25 ppm/°C						
Max. dissipation @ Tamb=70°C	1W	3/4W	2/5W	1/4W	1/8W	1/10W	1/10W
Max. Operating Voltage (DC or RMS)	200V	200V	200V	200V	150V	75V	50V
Operating Temperature	-55 ~ +155°C						
Basic Specification	JIS C5201-1 / IEC 60115-1 /AEC-Q200						

■ **High Precision Thin Film (AEC-Q200 Compliant) TC15 / 10 WFxxF & W\_Q Series (E192+E24 series)**

Series No.	WF25F&W_Q	WF20F&W_Q	WF10F&W_Q	WF12F&W_Q	WF08F&W_Q	WF06F&W_Q	WF04F&W_Q
Size	2512(6432)	2010(5025)	1210(3225)	1206 (3216)	0805 (2012)	0603 (1608)	0402 (1005)
Resistance Tolerance	±1%, ±0.5%, ±0.25%, ±0.1%, ±0.05%, ±0.02%, ±0.01%						
Resistance Range	10~ 1.5MΩ	10~ 1MΩ	10~ 600KΩ	4.7~ 500KΩ	4.7~ 400KΩ	4.7~ 150KΩ	10~ 60KΩ
TCR (ppm/°C)	±15 / 10 ppm/°C						
Max. dissipation @ Tamb=70°C	1W	3/4W	2/5W	1/4W	1/8W	1/10W	1/10W
Max. Operating Voltage (DC or RMS)	200V	200V	200V	200V	150V	75V	50V
Operating Temperature	-55 ~ +155°C						
Basic Specification	JIS C5201-1 / IEC 60115-1/AEC-Q200						

■ **High Precision Thin Film (AEC-Q200 Compliant) TC5 WFxxZ\_Q Series (E192+E24 series)**

Series No.	WF25Z_Q	WF20Z_Q	WF10Z_Q	WF12Z_Q	WF08Z_Q	WF06Z_Q	WF04Z_Q
Size	2512(6432)	2010(5025)	1210(3225)	1206 (3216)	0805 (2012)	0603 (1608)	0402 (1005)
Resistance Tolerance	±1%, ±0.5%, ±0.25%, ±0.1%, ±0.05%, ±0.02%, ±0.01%						
Resistance Range	10~ 600KΩ	10~ 360KΩ	10~ 150KΩ	4.7~ 150KΩ	4.7~ 100KΩ	4.7~ 50KΩ	10~ 10KΩ
TCR (ppm/°C)	±5 ppm/°C						
Max. dissipation @ Tamb=70°C	1W	3/4W	2/5W	1/4W	1/8W	1/10W	1/10W
Max. Operating Voltage (DC or RMS)	200V	200V	200V	200V	150V	75V	50V
Operating Temperature	-55 ~ +155°C						
Basic Specification	JIS C5201-1 / IEC 60115-1 /AEC-Q200						

■ **High Precision Thin Film (AEC-Q200 Compliant) TC3 WFxxB\_Q Series (E192+E24 series)**

Series No.	WF25B_Q	WF20B_Q	WF10B_Q	WF12B_Q	WF08B_Q	WF06B_Q	WF04B_Q
Size	2512(6432)	2010(5025)	1210(3225)	1206 (3216)	0805 (2012)	0603 (1608)	0402 (1005)
Resistance Tolerance	±1%, ±0.5%, ±0.25%, ±0.1%, ±0.05%, ±0.02%, ±0.01%						
Resistance Range	10~ 600KΩ	10~ 360KΩ	10~ 150KΩ	4.7~ 120KΩ	4.7~ 80KΩ	4.7~ 40KΩ	10~ 8KΩ
TCR (ppm/°C)	±3 ppm/°C						
Max. dissipation @ Tamb=70°C	1W	3/4W	2/5W	1/4W	1/8W	1/10W	1/10W
Max. Operating Voltage (DC or RMS)	200V	200V	200V	200V	150V	75V	50V
Operating Temperature	-55 ~ +155°C						
Basic Specification	JIS C5201-1 / IEC 60115-1 /AEC-Q200						

■ **High Precision Thin Film (AEC-Q200 Compliant) TC2 WFxxC\_Q Series (E192+E24 series)**

Series No.	WF25C_Q	WF20C_Q	WF10C_Q	WF12C_Q	WF08C_Q	WF06C_Q	WF04C_Q
Size	2512(6432)	2010(5025)	1210(3225)	1206 (3216)	0805 (2012)	0603 (1608)	0402 (1005)
Resistance Tolerance	±1%, ±0.5%, ±0.25%, ±0.1%, ±0.05%, ±0.02%, ±0.01%						
Resistance Range	10~ 600KΩ	10~ 360KΩ	10~ 150KΩ	4.7~ 120KΩ	4.7~ 80KΩ	4.7~ 40KΩ	10~ 8KΩ
TCR (ppm/°C)	±2 ppm/°C						
Max. dissipation @ Tamb=70°C	1W	3/4W	2/5W	1/4W	1/8W	1/10W	1/10W
Max. Operating Voltage (DC or RMS)	200V	200V	200V	200V	150V	75V	50V
Operating Temperature	-55 ~ +155°C						
Basic Specification	JIS C5201-1 / IEC 60115-1 /AEC-Q200						

Detail specification please refer to specific data sheets

■ **Thin Film Anti-Sulfuration Chip Resistor: SF Series**

■ **Feature**

1. SMD metal film resistor
2. High reliability and stability of 0.5% and below per customer request
3. High performance of TCR: 25 & 15ppm/°C and below per customer request
4. Low current noise
5. Sulfuration resistant against ASTM B-809
6. RoHS compliant and Lead free.

■ **Application**

1. Farming and industrial Equipment
2. Medical equipment
3. Measuring instrument
4. Communication device.

■ **Thin Film Anti-Sulfuration- SF Series TC50 / 25 SFxxT & U Series (E192+E24 series)**

Series No.	SF25T&U	SF20T&U	SF10T&U	SF12T&U	SF08T&U	SF06T&U	SF04T&U
Size	2512(6432)	2010(5025)	1210(3225)	1206(3216)	0805(2012)	0603(1608)	0402(1005)
Resistance Tolerance	±1% , ±0.5% , ±0.25% , ±0.1% , ±0.05%*						
Resistance Range	1~3MΩ	4.7~3MΩ	4.7~2.5MΩ	1~2.5MΩ	4.7~2MΩ	4.7~ 1MΩ	10 ~ 255KΩ
TCR (ppm/°C)	±50 /25 ppm/°C						
Max. dissipation @ Tamb=70°C	3/4W	1/2W	1/4W	1/8W	1/10W	1/16W	1/16W
Max. Operating Voltage (DC or RMS)	200V	200V	200V	200V	150V	75V	50V
Operating Temperature	-55 ~ +155°C						
Basic Specification	JIS C5201-1 / IEC 60115-1 / ASTM B-809						

■ **Thin Film Anti-Sulfuration- SF Series TC50 / 25 SFxx Q & R (Power) Series (E192+E24 series)**

Series No.	SF25Q&R	SF20Q&R	SF10Q&R	SF12Q&R	SF08Q&R	SF06Q&R	SF04Q&R
Size	2512(6432)	2010(5025)	1210(3225)	1206(3216)	0805(2012)	0603(1608)	0402(1005)
Resistance Tolerance	±1% , ±0.5% , ±0.25% , ±0.1% , ±0.05%*						
Resistance Range	1Ω ~ 3MΩ	4.7Ω ~ 3MΩ	4.7Ω ~2.5MΩ	1Ω ~ 2.5MΩ	4.7Ω~ 2MΩ	4.7Ω~ 1MΩ	10Ω ~ 255KΩ
TCR (ppm/°C)	±50 /25 ppm/°C						
Max. dissipation @ Tamb=70°C	1W	3/4W	2/5W	1/4W	1/8W	1/10W	1/10W
Max. Operating Voltage (DC or RMS)	200V	200V	200V	200V	150V	75V	50V
Operating Temperature	-55 ~ +155°C						
Basic Specification	JIS C5201-1 / IEC 60115-1 / ASTM B-809						

Detail specification please refer to specific data sheets

■ **Thin Film Anti-Sulfuration (ASTM B-809 & Under Oil 105°C+3.5% Sulfur power 500 hours): SF\_A Series**

■ **Feature**

1. SMD metal film resistor
2. High reliability and stability of 0.5% and below per customer request
3. High performance of TCR: 15 ppm/°C and below per customer request
4. Low current noise
5. RoHS compliant and lead free
6. Sulfuration resistant Oil 105°C+3.5% Sulfur powder x 500hrs

■ **Application**

1. Automotive
2. Medical equipment
3. Measuring instrument
4. Communication device
5. Computer
6. Printer

■ **Thin Film Anti-Sulfuration TC50 / 25 SFxxT & U\_A Series (E192+E24 series)**

Series No.	SF25T&U_A	SF20T&U_A	SF10T&U_A	SF12T&U_A	SF08T&U_A	SF06T&U_A	SF04T&U_A
Size	2512(6432)	2010(5025)	1210(3225)	1206(3216)	0805(2012)	0603(1608)	0402(1005)
Resistance Tolerance	±1% , ±0.5% , ±0.25% , ±0.1% , ±0.05%*						
Resistance Range	1Ω ~ 3MΩ	4.7Ω ~ 3MΩ	4.7Ω ~ 2.5MΩ	1 ~ 2.5MΩ	4.7~ 2MΩ	4.7~ 1MΩ	10~ 255KΩ
TCR (ppm/°C)	±50 / 25 ppm/°C						
Max. dissipation @ Tamb=70°C	3/4W	1/2W	1/4W	1/8W	1/10W	1/16W	1/16W
Max. Operating Voltage (DC or RMS)	200V	200V	200V	200V	150V	75V	50V
Operating Temperature	-55 ~ +155°C						
Basic Specification	JIS C5201-1 / IEC 60115-1 / ASTM B-809 / AEC-Q200						

■ **Thin Film Anti-Sulfuration TC50 / 25 SFxxQ & R\_A (Power) Series (E192+E24 series)**

Series No.	SF25Q&R_A	SF20Q&R_A	SF10Q&R_A	SF12Q&R_A	SF08Q&R_A	SF06Q&R_A	SF04Q&R_A
Size	2512(6432)	2010(5025)	1210(3225)	1206(3216)	0805(2012)	0603(1608)	0402(1005)
Resistance Tolerance	±1% , ±0.5% , ±0.25% , ±0.1% , ±0.05%*						
Resistance Range	1Ω ~ 3MΩ	4.7Ω ~ 3MΩ	4.7Ω ~ 2.5MΩ	1 ~ 2.5MΩ	4.7~ 2MΩ	4.7~ 1MΩ	10~ 255KΩ
TCR (ppm/°C)	±50 / 25 ppm/°C						
Max. dissipation @ Tamb=70°C	1W	3/4W	2/5W	1/4W	1/8W	1/10W	1/10W
Max. Operating Voltage (DC or RMS)	200V	200V	200V	200V	150V	75V	50V
Operating Temperature	-55 ~ +155°C						
Basic Specification	JIS C5201-1 / IEC 60115-1 / ASTM B-809 / AEC-Q200						

■ **Thin Film Anti-Sulfuration TC15 / 10 SFxxF& W\_A (Power) Series (E192+E24 series)**

Series No.	SF25F&W_A	SF20F&W_A	SF10F&W_A	SF12F&W_A	SF08F&W_A	SF06F&W_A	SF04F&W_A
Size	2512(6432)	2010(5025)	1210(3225)	1206(3216)	0805(2012)	0603(1608)	0402(1005)
Resistance Tolerance	±1.0% , ±0.5% , ±0.25% , ±0.1% , ±0.05% , ±0.02% , ±0.01%						
Resistance Range	10Ω ~ 1.5MΩ	10Ω ~ 1MΩ	10Ω ~ 600KΩ	4.7Ω~ 500KΩ	4.7Ω~ 400KΩ	4.7Ω~ 200KΩ	10Ω~ 100KΩ
TCR (ppm/°C)	±15 / 10 ppm/°C						
Max. dissipation @ Tamb=70°C	1W	3/4W	2/5W	1/4W	1/8W	1/10W	1/10W
Max. Operating Voltage (DC or RMS)	200V	200V	200V	200V	150V	75V	50V
Operating Temperature	-55 ~ +155°C						
Basic Specification	JIS C5201-1 / IEC 60115-1 / ASTM B-809 / AEC-Q200						

■ **Thin Film Anti-Sulfuration TC 5 SFxxZ\_A (Power) Series (E192+E24 series)**

Series No.	SF25Z_A	SF20Z_A	SF10Z_A	SF12Z_A	SF08Z_A	SF06Z_A	SF04Z_A
Size	2512(6432)	2010(5025)	1210(3225)	1206(3216)	0805(2012)	0603(1608)	0402(1005)
Resistance Tolerance	±1.0%, ±0.5%, ±0.25%, ±0.1%, ±0.05%						
Resistance Range	4.7Ω~600KΩ	4.7Ω~360KΩ	4.7Ω~150KΩ	4.7Ω~150KΩ	4.7Ω~100KΩ	4.7Ω~50KΩ	10Ω~ 10KΩ
TCR (ppm/°C)	±5 ppm/°C						
Max. dissipation @ Tamb=70°C	1W	3/4W	2/5W	1/4W	1/8W	1/10W	1/10W
Max. Operating Voltage (DC or RMS)	200V	200V	200V	200V	150V	75V	50V
Operating Temperature	-55 ~ +155°C						
Basic Specification	JIS C5201-1 / IEC 60115-1 / ASTM B-809 / AEC-Q200						

■ **Thin Film Anti-Sulfuration Chip Resistor (AEC-Q200/ASTM-B809-95\*): SF\_Q Series**

■ **Feature**

1. SMD metal film resistor
2. High reliability and stability of 0.5% and below per customer request
3. High performance of TCR: 15 ppm/°C and below per customer request
4. Low current noise
5. RoHS compliant and lead free
6. AEC-Q200 compliant.
7. Sulfuration resistant against ASTM B-809-95\*.

■ **Application**

1. Automotive
2. Medical equipment
3. Measuring instrument
4. Communication device
5. Computer
6. Printer

■ **Thin Film Anti-Sulfuration (AEC-Q200 Compliant & ASTM B-809) TC50 / 25 SFxxT & U\_Q Series (E192+E24 series)**

Series No.	SF25T&U_Q	SF20T&U_Q	SF10T&U_Q	SF12T&U_Q	SF08T&U_Q	SF06T&U_Q	SF04T&U_Q
Size	2512(6432)	2010(5025)	1210(3225)	1206(3216)	0805(2012)	0603(1608)	0402(1005)
Resistance Tolerance	±1% , ±0.5% , ±0.25% , ±0.1% , ±0.05%*						
Resistance Range	10~1.5MΩ	10 ~1.5MΩ	10~1MΩ	10 ~ 1MΩ	10~ 1MΩ	4.7~ 330KΩ	10~ 100KΩ
TCR (ppm/°C)	±50 / 25 ppm/°C						
Max. dissipation @ Tamb=70°C	3/4W	1/2W	1/4W	1/8W	1/10W	1/16W	1/16W
Max. Operating Voltage (DC or RMS)	200V	200V	200V	200V	100V	50V	50V
Operating Temperature	-55 ~ +155°C						
Basic Specification	JIS C5201-1 / IEC 60115-1 / ASTM B-809 / AEC-Q200						

■ **Thin Film Anti-Sulfuration (AEC-Q200 Compliant & ASTM B-809) TC50 / 25 SFxxQ & R\_Q (Power) Series (E192+E24 series)**

Series No.	SF25Q&R_Q	SF20Q&R_Q	SF10Q&R_Q	SF12Q&R_Q	SF08Q&R_Q	SF06Q&R_Q	SF04Q&R_Q
Size	2512(6432)	2010(5025)	1210(3225)	1206(3216)	0805(2012)	0603(1608)	0402(1005)
Resistance Tolerance	±1% , ±0.5% , ±0.25% , ±0.1% , ±0.05%*						
Resistance Range	10~1.5MΩ	10 ~1.5MΩ	10~1MΩ	10 ~ 1MΩ	10~ 1MΩ	4.7~ 330KΩ	10~ 100KΩ
TCR (ppm/°C)	±50 / 25 ppm/°C						
Max. dissipation @ Tamb=70°C	1W	3/4W	2/5W	1/4W	1/8W	1/10W	1/10W
Max. Operating Voltage (DC or RMS)	200V	200V	200V	200V	150V	75V	50V
Operating Temperature	-55 ~ +155°C						
Basic Specification	JIS C5201-1 / IEC 60115-1 / ASTM B-809 / AEC-Q200						

■ **Thin Film Anti-Sulfuration (AEC-Q200 Compliant & ASTM B-809) TC15 / 10 SFxxF & W\_Q Series (E192+E24 series)**

Series No.	SF25F&W_Q	SF20F&W_Q	SF10F&W_Q	SF12F&W_Q	SF08F&W_Q	SF06F&W_Q	SF04F&W_Q
Size	2512(6432)	2010(5025)	1210(3225)	1206(3216)	0805(2012)	0603(1608)	0402(1005)
Resistance Tolerance	±1% , ±0.5% , ±0.25% , ±0.1% , ±0.05%*						
Resistance Range	10 ~1.5MΩ	10 ~900KΩ	10~400KΩ	10~300KΩ	10~200KΩ	10~ 100KΩ	10~ 20KΩ
TCR (ppm/°C)	±15 /10 ppm/°C						
Max. dissipation @ Tamb=70°C	1W	3/4W	2/5W	1/4W	1/8W	1/10W	1/10W
Max. Operating Voltage (DC or RMS)	200V	200V	200V	200V	150V	75V	50V
Operating Temperature	-55 ~ +155°C						
Basic Specification	JIS C5201-1 / IEC 60115-1 / ASTM B-809 / AEC-Q200						

■ **Thin Film Anti-Sulfuration (AEC-Q200 Compliant & ASTM B-809) TC5 SFxxZ\_Q Series (E192+E24 series)**

Series No.	SF25Z_Q	SF20Z_Q	SF10Z_Q	SF12Z_Q	SF08Z_Q	SF06Z_Q	SF04Z_Q
Size	2512(6432)	2010(5025)	1210(3225)	1206(3216)	0805(2012)	0603(1608)	0402(1005)
Resistance Tolerance	±1% , ±0.5% , ±0.25% , ±0.1% , ±0.05%*						
Resistance Range	4.7~600KΩ	4.7~360KΩ	4.7~150KΩ	4.7~150KΩ	4.7~100KΩ	4.7~ 50KΩ	10~ 10KΩ
TCR (ppm/°C)	±5 ppm/°C						
Max. dissipation @ Tamb=70°C	1W	3/4W	2/5W	1/4W	1/8W	1/10W	1/10W
Max. Operating Voltage (DC or RMS)	200V	200V	200V	250V	150V	75V	50V
Operating Temperature	-55 ~ +155°C						
Basic Specification	JIS C5201-1 / IEC 60115-1 / ASTM B-809 / AEC-Q200						

Detail specification please refer to specific data sheets

■ **TaN Thin Film Chip Resistor (Auto Grade/AEC-Q200/ASTM B-809): MF Series**

■ **Feature**

1. SMD TaN thin film resistor
2. Special passivation layer on resistive file
3. AEC-Q200 qualified
4. Products with lead free terminations meet RoHS requirements
5. Sulfur resistant (per ASTM B809-95 humid vapor test)
6. Laser trimmed to any value.

■ **Application**

1. Professional Industrial equipment
2. Automotive
3. Medical equipment
4. Measuring instrument
5. Industrial Equipment.

■ **TaN Thin Film (Auto Grade/AEC-Q200 & ASTM B-809) TC25 / 50 MFxxQ & R Series (E192+E24 series)**

Series No.	MF12Q&R	MF08Q&R	MF06Q&R	MF04Q&R
Size	1206(3216)	0805(2012)	0603(1608)	0402(1005)
Resistance Tolerance	±1% , ±0.5% , ±0.25% , ±0.1% , ±0.05% ,			
Resistance Range	10Ω ~ 1MΩ	10Ω ~ 350KΩ	40Ω ~ 130KΩ	40Ω ~ 35KΩ
TCR (ppm/°C)	±50 /25 ppm/°C			
Max. dissipation at T <sub>amb</sub> =85°C	0.4W	0.2W	0.15W	0.063W
Max. Operating Voltage (DC or RMS)	200V	100V	75V	50V
Operating Temperature	-55 ~ +155°C			
Basic Specification	JIS C5201-1 / IEC 60115-1 / AEC Q200 /ASTM B-809			

■ **TaN Thin Film (Auto Grade/AEC-Q200 & ASTM B-809) TC15 / 10 MFxxF & W Series (E192+E24 series)**

Series No.	MF12F&W	MF08F&W	MF06F&W	MF04F&W
Size	1206(3216)	0805(2012)	0603(1608)	0402(1005)
Resistance Tolerance	±1% , ±0.5% , ±0.25% , ±0.1% , ±0.05% ,			
Resistance Range	10Ω ~ 1MΩ	10Ω ~ 350KΩ	40Ω ~ 130KΩ	40Ω ~ 35KΩ
TCR (ppm/°C)	±15 /10 ppm/°C			
Max. dissipation at Tamb=85°C	0.4W	0.2W	0.15W	0.063W
Max. Operating Voltage (DC or RMS)	200V	100V	75V	50V
Operating Temperature	-55 ~ +155°C			
Basic Specification	JIS C5201-1 / IEC 60115-1 / AEC Q200 /ASTM B-809			

Detail specifications please refer to specific data sheets.

■ **Thin Film Low Ohmic Current Sensor: WW Series**

■ **Feature**

1. SMD metal film resistor
2. High reliability and stability.
3. High performance of TCR.
4. Power Rating up to 2W.

■ **Application**

1. Current sensor
2. Medical equipment
3. Measuring instrument
4. Communication device
5. Printer.

■ **Thin Film Low Ohmic Current Sensor – WWxxF & G & H Series (E96 series)**

Series No.	WW25		WW20		WW12		
	F	G	F	G	H	F	G
Code	F G		F G		H F G		
Size	2512(6432)		2010(5025)		1210(3225)		
Resistance Tolerance	± 0.5% , ± 1%						
Resistance Range	101m-900mΩ	21m-900mΩ	101m-900mΩ	21m-900mΩ	101m-900mΩ		21m-900mΩ
TCR (ppm/°C)	± 75	± 100	± 75	± 100	± 75	± 75	± 100
Power	2W		1W		1W	1/2W	
Operating Temperature	-55 ~ +155°C						

Series No.	WW08		WW06		WW04	
	F	G	F	G	F	G
Code	F G		F G		F G	
Size	1206(3216)		0805(2012)		0603(1608)	
Resistance Tolerance	± 0.5% , ± 1%					
Resistance Range	101m-900mΩ	21m-900mΩ	101m-900mΩ	21m-900mΩ	101m-900mΩ	21m-900mΩ
TCR (ppm/°C)	± 75	± 100	± 75	± 100	± 75	± 100
Power	1/4W		1/8W		1/10W	
Operating Temperature	-55 ~ +155°C					

■ Thin Film Foil Current Sensor: TTL Series (High Power / Low TCR/Tight Tolerance)

■ Feature

1. High power rating with low TCR.
2. Extra low resistance and high precision
3. High component and equipment reliability
4. Low resistances applied to current sensing
5. RoHS compliant & Halogen Free.
6. Suitable for lead free soldering.

■ Application

1. Current sensor
2. Medical equipment
3. Measuring instrument
4. Communication device
5. Power supply
6. Printer.

■ Thin Film Foil Current Sensor – TTLxxG, H, I, J, K, M, P & Q Series (E96 Series)

Series No.	TTL25			TTL12				TTL08		
Code	P	Q	J	K	M	P	J	K	M	
Size	2512(6432)			1206(3216)				0805(2012)		
Resistance Tolerance	± 0.5%(>10mΩ), ± 1% , ± 5%									
Resistance Range	5m-20mΩ			5m-20mΩ				5m-20mΩ		
TCR (ppm/°C)	±50 ,±75 ,±100			± 75				± 75		
Power	1W	2W	1/4W	1/3W	1/2W	1W	1/4W	1/3W	1/2W	
Operating Temperature	-55 ~ +155°C									

Series No.	TTL06				TTL04				
Code	I	J	K	M	H	I	J	K	M
Size	0603(1608)				0402(1005)				
Resistance Tolerance	± 0.5%(>10mΩ), ± 1% , ± 5%								
Resistance Range	5m-20mΩ				2.5m-20mΩ				
TCR (ppm/°C)	± 75				± 150				
Power	1/5W	1/4W	1/3W	1/2W	1/8W	1/5W	1/4W	1/3W	1/2W
Operating Temperature	-55 ~ +155°C								



■ MELF Thin Film Resistor: WM Series (AEC-Q200)

■ Feature

1. SMD enabled structure thin film resistor
2. High reliability and stability of  $\pm 0.5\%$  and below per customer request
3. Power rating up to 1Watt.
4. Best in class pulse load capability.

■ Application

1. Medical equipment
2. Measuring instrument
3. Power / Meter Converter.

■ MELF Thin Film Resistor (AEC-Q200 Compliant) TC50 / 25 WMxxB & C Series (E192+E24 series)

Series No.	WM07B	WM07C	WM04B	WM04C
Size code	0207 ( 6123 )		0204 ( 3715 )	
Resistance Tolerance	$\pm 1\%$ , $\pm 0.5\%$ , $\pm 0.25\%$ , $\pm 0.1\%$			
Resistance Range	0.2 ~ 1M $\Omega$	10 ~ 1M $\Omega$	0.2~ 1M $\Omega$	10 ~ 1M $\Omega$
TCR (ppm/ $^{\circ}$ C)	$\pm 50$ ppm/ $^{\circ}$ C	$\pm 25$ ppm/ $^{\circ}$ C	$\pm 50$ ppm/ $^{\circ}$ C	$\pm 25$ ppm/ $^{\circ}$ C
Max. dissipation at Tamb=70 $^{\circ}$ C	1/2W		1/4W	
Max. Operating Voltage (DC or RMS)	300V		200V	
Operating Temperature	- 55 ~ +155 $^{\circ}$ C			

■ MELF Thin Film Resistor (AEC-Q200 Compliant) TC50 / 25 WMxxN & O (Power) Series (E192+E24 series)

Series No.	WM07N	WM07O	WM04N	WM04O
Size code	0207 ( 6123 )		0204 ( 3715 )	
Resistance Tolerance	$\pm 1\%$ , $\pm 0.5\%$ , $\pm 0.25\%$ , $\pm 0.1\%$			
Resistance Range	0.2~ 1M $\Omega$	10 ~ 1M $\Omega$	0.2~ 1M $\Omega$	10 ~ 1M $\Omega$
TCR (ppm/ $^{\circ}$ C)	$\pm 50$ ppm/ $^{\circ}$ C	$\pm 25$ ppm/ $^{\circ}$ C	$\pm 50$ ppm/ $^{\circ}$ C	$\pm 25$ ppm/ $^{\circ}$ C
Max. dissipation at Tamb=70 $^{\circ}$ C	1W		2/5W	
Max. Operating Voltage (DC or RMS)	350V		200V	
Operating Temperature	- 55 ~ +155 $^{\circ}$ C			

■ MELF Thin Film Resistor (AEC-Q200 Compliant) TC15 /10 WMxxD & E Series (E192+E24 series)

Series No.	WM07D	WM07E	WM04D	WM04E
Size code	0207 ( 6123 )		0204 ( 3715 )	
Resistance Tolerance	$\pm 1\%$ , $\pm 0.5\%$ , $\pm 0.25\%$ , $\pm 0.1\%$			
Resistance Range	49.9~ 250K $\Omega$	49.9~ 25K $\Omega$	49.9~ 250K $\Omega$	49.9~ 25K $\Omega$
TCR (ppm/ $^{\circ}$ C)	$\pm 15$ ppm/ $^{\circ}$ C	$\pm 10$ ppm/ $^{\circ}$ C	$\pm 15$ ppm/ $^{\circ}$ C	$\pm 10$ ppm/ $^{\circ}$ C
Max. dissipation at Tamb=70 $^{\circ}$ C	1/2W		1/4W	
Max. Operating Voltage (DC or RMS)	300V		200V	
Operating Temperature	- 55 ~ +155 $^{\circ}$ C			

■ MELF Thin Film Resistor (AEC-Q200 Compliant) TC15 /10 WMxxP & Q (Power) Series (E192+E24 series)

Series No.	WM07P	WM07Q	WM04P	WM04Q
Size code	0207 ( 6123 )		0204 ( 3715 )	
Resistance Tolerance	$\pm 1\%$ , $\pm 0.5\%$ , $\pm 0.25\%$ , $\pm 0.1\%$			
Resistance Range	49.9~ 250K $\Omega$	49.9~ 25K $\Omega$	49.9~ 250K $\Omega$	49.9~ 25K $\Omega$
TCR (ppm/ $^{\circ}$ C)	$\pm 15$ ppm/ $^{\circ}$ C	$\pm 10$ ppm/ $^{\circ}$ C	$\pm 15$ ppm/ $^{\circ}$ C	$\pm 10$ ppm/ $^{\circ}$ C
Max. dissipation at Tamb=70 $^{\circ}$ C	1W		2/5W	
Max. Operating Voltage (DC or RMS)	350V		200V	
Operating Temperature	- 55 ~ +155 $^{\circ}$ C			

■ MELF Thin Film Resistor Jumper WM07X & WM04X

Series No.	WM07X	WM04X
Size code	0207 ( 6123 )	0204 ( 3715 )
Resistance Tolerance	$\pm 5\%$	
Resistance Range	0 $\Omega$ (<15m $\Omega$ )	
TCR (ppm/ $^{\circ}$ C)	-	
Max. dissipation at Tamb=70 $^{\circ}$ C	Jumper 4A	Jumper 2A
Max. Operating Voltage (DC or RMS)	300V	200V
Operating Temperature	- 55 ~ +155 $^{\circ}$ C	

Detail specification please refer to specific data sheets

■ **Test and Requirements**

■ **For WR Series**

Test	Procedure / Test Method	Requirements	
		Resistor	0Ω
Electrical Characteristics JISC5201-1: 1998 Clause 4.8	- DC resistance values measurement - Temperature Coefficient of Resistance (T.C.R) Natural resistance change per change in degree centigrade. $R2-R1/R1(T2-T1) \times 10^6$ (ppm/°C) T1:20°C+5°C-1°C R1:Resistance at reference temperature (20°C+5°C/-1°C) R2:Resistance at test temperature (-55°C or +155°C)	Within the specified tolerance Refer to "QUICK REFERENCE DATA"	< 50mΩ
Resistance to soldering heat(R.S.H) JISC5201-1:1998 Clause 4.18	Un-mounted chips completely immersed for 10±1second in a SAC solder bath at 260°C±5°C	±5%: $\Delta R/R_{max}$ . (1%+0.05Ω) ±1%: $\Delta R/R_{max}$ . (0.5%+0.05Ω) no visible damage	< 50mΩ
Solderability JISC5201-1:1998 Clause 4.17	Un-mounted chips completely immersed for 2±0.5 second in a SAC solder bath at 235°C±5°C	95% coverage min., good tinning and no visible damage	
Temperature cycling JISC5201-1:1998 Clause 4.19	30minutes at -55°C±3°C, 2~3minutes at 20°C+5°C-1°C,30minutes at +155°C±3°C,2~3minutes at 20°C+5°C-1°C,total 5continuous cycles	±5%: $\Delta R/R_{max}$ . (1%+0.05Ω) ±1%: $\Delta R/R_{max}$ . (0.5%+0.05Ω) no visible damage	< 50mΩ
High Temperature Exposure MIL-STD-202 Method 108	1000+48/-0 hours; without load in a temperature chamber controlled 155°C±3°C	±5%: $\Delta R/R_{max}$ . (2%+0.1Ω) ±1%: $\Delta R/R_{max}$ . (1%+0.1Ω) no visible damage	< 50mΩ
Bending strength JISC5201-1:1998 Clause 4.33	Resistors mounted on a 90mm glass epoxy resin PCB(FR-4), bending once 3mm for 10sec, 5mm for WR04	±5%: $\Delta R/R_{max}$ . (1%+0.05Ω) ±1%: $\Delta R/R_{max}$ . (1%+0.05Ω) no visible damage	< 50mΩ
Adhesion JISC5201-1:1998 Clause 4.32	Pressurizing force: 5N, Test time: 10±1sec.	No remarkable damage or removal of the terminations	
Short Time Overload (STOL) JISC5201-1:1998 Clause 4.13	2.5 times RCWV or max. overload voltage, for 5seconds	±5%: $\Delta R/R_{max}$ . (2%+0.1Ω) ±1%: $\Delta R/R_{max}$ . (1%+0.1Ω) no visible damage	< 50mΩ
Load life in Humidity JISC5201-1:1998 Clause 4.24	1000+48/-0 hours, loaded with RCWV or Vmax in humidity chamber controller 40°C±2°Cat and 90~95% relative humidity, 1.5 hours on and 0.5 hours off	±5%: $\Delta R/R_{max}$ . (2%+0.1Ω) ±1%: $\Delta R/R_{max}$ . (1%+0.1Ω) no visible damage	< 50mΩ
Load life (endurance) JISC5201-1:1998 Clause 4.25	1000+48/-0 hours, loaded with RCWV or Vmax in chamber controller 70°C±2°C 1.5 hours on and 0.5 hours off	±5%: $\Delta R/R_{max}$ . (2%+0.1Ω) ±1%: $\Delta R/R_{max}$ . (1%+0.1Ω) no visible damage	< 50mΩ
Insulation Resistance JISC5201-1:1998 Clause 4.6	Apply the maximum overload voltage (DC) for 1minute	$R \geq 10G\Omega$	
Dielectric Withstand Voltage JISC5201-1:1998 Clause 4.7	Apply the maximum overload voltage (AC) for 1minute	No breakdown or flashover	

■ Test and Requirements

■ For WW Series

Test	Procedure / Test Method	Requirements
		Resistor
Electrical Characteristics JISC5201-1: 1998 Clause 4.8	- DC resistance values measurement - Temperature Coefficient of Resistance (T.C.R) Natural resistance change per change in degree centigrade. $R2-R1/R1(T2-T1) \times 10^6$ (ppm/°C) T1:20°C+5°C-1°C R1:Resistance at reference temperature (20°C+5°C/-1°C) R2:Resistance at test temperature (-55°C or +155°C)	Within the specified tolerance Refer to "QUICK REFERENCE DATA"
Resistance to soldering heat(R.S.H) JISC5201-1:1998 Clause 4.18	Un-mounted chips completely immersed for 10±1second in a SAC solder bath at 260°C±5°C	ΔR/R max. ±(1%+0.005Ω) no visible damage
Solderability JISC5201-1:1998 Clause 4.17	Un-mounted chips completely immersed for 2±0.5 second in a SAC solder bath at 235°C±5°C	95% coverage min., good tinning and no visible damage
Temperature cycling JISC5201-1:1998 Clause 4.19	30minutes at -55°C±3°C, 2~3minutes at 20°C+5°C-1°C,30minutes at +155°C±3°C,2~3minutes at 20°C+5°C-1°C,total 5continuous cycles	ΔR/R max. ±(1%+0.005Ω) no visible damage
High Temperature Exposure MIL-STD-202 Method 108	1000+48/-0 hours; without load in a temperature chamber controlled 155°C±3°C	ΔR/R max. ±(3%+0.005Ω) no visible damage
Bending strength JISC5201-1:1998 Clause 4.33	Resistors mounted on a 90mm glass epoxy resin PCB(FR-4), bending once 3mm for 10sec, 5mm for WR04	ΔR/R max. ±(1%+0.005Ω) no visible damage
Adhesion JISC5201-1:1998 Clause 4.32	Pressurizing force: 5N, Test time: 10±1sec.	No remarkable damage or removal of the terminations
Short Time Overload (STOL) JISC5201-1:1998 Clause 4.13	2.5 times RCWV or max. overload voltage, for 5seconds	ΔR/R max. ±(2%+0.005Ω) no visible damage
Load life in Humidity JISC5201-1:1998 Clause 4.24	1000+48/-0 hours, loaded with RCWV or Vmax in humidity chamber controller 40°C±2°Cat and 90~95% relative humidity, 1.5 hours on and 0.5 hours off	ΔR/R max. ±(3%+0.005Ω) no visible damage
Load life (endurance) JISC5201-1:1998 Clause 4.25	1000+48/-0 hours, loaded with RCWV or Vmax in chamber controller 70°C±2°C 1.5 hours on and 0.5 hours off	ΔR/R max. ±(3%+0.005Ω) no visible damage
Insulation Resistance JISC5201-1:1998 Clause 4.6	Apply the maximum overload voltage (DC) for 1minute	$R \geq 10G\Omega$
Dielectric Withstand Voltage JISC5201-1:1998 Clause 4.7	Apply the maximum overload voltage (AC) for 1minute	No breakdown or flashover

■ **Test and Requirements**

■ **For MF Series (Auto Grade/ AEC-Q200/ Thin Film)**

Test	Procedure / Test Method	Requirements
		Resistor
Electrical Characteristics IEC 60115-1 4.8	- DC resistance values measurement - Temperature Coefficient of Resistance (T.C.R) Natural resistance change per change in degree centigrade.  $\frac{R_2 - R_1}{R_1(t_2 - t_1)} \times 10^6$ (ppm/°C) t1: 20°C+5°C-1°C  R1 : Resistance at reference temperature (20°C+5°C-1°C) R2 : Resistance at test temperature (-55°C or +125°C)	Within the specified tolerance
Short time overload (S.T.O.L) IEC60115-1 4.13	Permanent resistance change after a 5second application of a voltage 2.5 times RCWV or the maximum overload voltage specified in the above list, whichever is less.	R/R max. ±(0.1%+0.02)
Resistance to soldering heat(R.S.H) AEC-Q200-15	Un-mounted chips completely immersed for 10±1second in a SAC solder bath at 260°C±5°C	no visible damage R/R max. ±(0.1%+0.02)
Solderability IEC 60068-2-58	Un-mounted chips completely immersed for 2±0.5 second in a SAC solder bath at 235°C±5°C	good tinning (>95% covered) no visible damage
Temperature cycling JESD22 method JA-104	1000 cycles, -55°C ~ +125°C, dwell time 5~10min	R/R max. ±(0.1%+0.02)
	1000 cycles, -55°C ~ +155°C, dwell time 5~10min	R/R max. ±(0.2%+0.02)
Bias Humidity AEC-Q200-7	1000 +48/-0 hours, loaded with 10% rated power in humidity chamber controller at +85°C/ 85%RH	R/R max. (0.1%+0.02)
Load Life IEC60115-1 4.25	1000 +48/-0 hours, loaded with RCWV or Vmax in chamber controller 85 ±2°C, 1.5 hours on and 0.5 hours off	R/R max. (0.1%+0.02)
Operational Life AEC Q200-8 MIL-STD-202-108	1000 hours at 125±2°C, loaded with rated power continuously	R/R max. (0.1%+0.02)
High Temperature Exposure AEC-Q200-3	1000 hours @ 125°C, un-powered	R/R max. (0.1%+0.02)
	1000 hours @ 155°C, un-powered	R/R max. ±(0.15%+0.02)
Moisture Resistance AEC-Q200-6 MIL-STD-202 Method 106	65±2°C, 80~100% RH, 10 cycles, 24 hours/ cycle	R/R max. (0.1%+0.02)
Mechanical Shock MIL-STD-202 Method 213	1/2 Sine Pulse / 1500g Peak / Velocity 15.4ft/sec	R/R max. (0.1%+0.02)
Vibration MIL-STD-202 Method 204	5 g's for 20 min, 12 cycles each of 3 orientations	R/R max. (0.1%+0.02)
Terminal strength AEC-Q200-6	1 kg for 60 s	No broken
Board flex AEC-Q200-21	Bending 2mm for 60 sec	R/R max. (0.1%+0.02)
Flower of sulfur ASTM-B809-95	105±2°C, duration 1000hours.	0402 ΔR/R max. ±(0.2%+0.02Ω) Others ΔR/R max. ±(0.1%+0.02Ω)

■ Test and Requirements

■ For WF Series (Thin Film)

Test	Procedure / Test Method	Requirements
		Resistor
DC resistance Clause 4.5	DC resistance values measured	Within the specified tolerance
Temperature Coefficient of Resistance(T.C.R) Clause 4.8	Natural resistance change per change in degree centigrade. $\frac{R_2 - R_1}{R_1(t_2 - t_1)} \times 10^6 \text{ (ppm/}^\circ\text{C)}$ R1 : Resistance at reference temperature R2 : Resistance at test temperature t1 : 20°C+5°C-1°C t2 : 125°C+5°C-1°C	Refer to " QUICK REFERENCE DATA "
Short time overload (S.T.O.L) Clause 4.13	Permanent resistance change after a 5second application of a voltage 2.5 times RCWV or the maximum overload voltage specified in the above list, whichever is less.	$\Delta R/R$ max. $\pm(0.1\%+0.05\Omega)$
Resistance to soldering heat(R.S.H) IEC 60068-2-58:2004	Un-mounted chips completely immersed for 10±1second in a SAC solder bath at 260°C±5°C	no visible damage $\Delta R/R$ max. $\pm(0.1\%+0.05\Omega)$
Solder ability IEC 60068-2-58:2004	Un-mounted chips completely immersed for 2±0.5 second in a SAC solder bath at 235°C±5°C	good tinning (>95% covered) no visible damage
Temperature cycling Clause 4.19	30 minutes at -55°C±3°C, 2~3 minutes at 20°C+5°C-1°C, 30 minutes at +155°C±3°C, 2~3 minutes at 20°C+5°C-1°C, total 5 continuous cycles	no visible damage $\Delta R/R$ max. $\pm(0.25\%+0.05\Omega)$
Load Life (Endurance) Clause 4.25	70±2°C, 1000 hours, loaded with RCWV or Vmax,1.5 hours on and 0.5 hours off	$\Delta R/R$ max. $\pm(0.25\%+0.05\Omega)$
Humidity Clause 4.24	1000 hours, at rated continuous working voltage in humidity chamber controller at 40°C±2°C and 90~95% relative humidity, 1.5hours on and 0.5 hours off	$\Delta R/R$ max. $\pm(0.25\%+0.05\Omega)$
Bending strength Clause 4.33	Resistors mounted on a 90mm glass epoxy resin PCB(FR4); bending : 3 mm, once for 10 seconds.	$\Delta R/R$ max. $\pm(0.1\%+0.05\Omega)$
Adhesion Clause 4.32	Pressurizing force: 5N, Test time: 10±1sec.	No remarkable damage or removal of the terminations.

■ Test and Requirements

■ For TTL Series (Thin Film Foil Current Sensor)

Test	Procedure / Test Method	Requirements
		Resistor
DC resistance IEC 60115-1 / JIS C 5201-1 , Clause 4.5	D: $\pm 0.5\%$ , F: $\pm 1\%$ ,	Within the specified tolerance
Temperature Coefficient of Resistance(T.C.R)	Natural resistance change per change in degree centigrade.  (ppm/ $^{\circ}$ C)  R1 : Resistance at reference temperature R2 : Resistance at test temperature t1 : 20 $^{\circ}$ C+5 $^{\circ}$ C-1 $^{\circ}$ C t2 : 125 $^{\circ}$ C+5 $^{\circ}$ C-1 $^{\circ}$ C	Refer to " QUICK REFERENCE DATA "
Short time overload (S.T.O.L) IEC60115-1 4.13	5 times of rated power for 5 seconds at room temperature	No visible damage $\pm(1.0\%+0.0005\Omega)$
Resistance to soldering heat(R.S.H) MIL-STD-202G-method 210F IEC 60115-1 4.18	Condition B, no pre-heat of samples Lead free solder, 260 $^{\circ}$ C, 10 seconds immersion time Procedure 2 for SMD: devices fluxed and cleaned with isopropanol	No visible damage $\pm(0.5\%+0.0005\Omega)$
Solderability IPC/JEDEC J-STD-002B test B	SMD conditions: 1st step: method B, aging 4 hours at 155 $^{\circ}$ C dry heat 2nd step: leadfree solder bath at 245 $\pm$ 3 $^{\circ}$ C Dipping time: 3 $\pm$ 0.5 seconds	good tinning (>95% covered) no visible damage
Thermal Shock MIL-STD-202G-method 107	-55/+125 $^{\circ}$ C Note: Number of cycles required is 300. Devices mounted Maximum transfer time is 20 seconds. Dwell time is 15 minutes. Air – Air	$\pm(1.0\%+0.0005\Omega)$
Endurance MIL-STD-202G-method 108 IEC 60115-1 4.25.1	70 $\pm$ 2 $^{\circ}$ C, 1000 hours, loaded with RCWV, 1.5 hours on and 0.5 hours off	(2.0%+0.0005 $\Omega$ )
Bending Strength IEC60115-1 4.33	Device mounted on PCB test board as described, only 1 board bending required Bending for 0201: 3mm 0402 and above: 2mm Holding time: minimum 60 seconds	$\pm(1.0\%+0.0005\Omega)$
High Temperature Exposure MIL-STD-202G-method 108 IEC 60115-1 4.25.3	1,000 hours at maximum operating temperature depending on specification, unpowered No direct impingement of forced air to the parts Tolerances: 0201: 125 $\pm$ 3 $^{\circ}$ C 0402 and above 155 $\pm$ 3 $^{\circ}$ C	$\pm(1.0\%+0.0005\Omega)$
Moisture Resistance MIL-STD-202G-method 106	Each temperature / humidity cycle is defined at 8 hours (method 106F), 3 cycles / 24 hours for 10d with 25 $^{\circ}$ C / 65 $^{\circ}$ C 95% R.H, without steps 7a & 7b, unpowered Parts mounted on test-boards, without condensation on parts Measurement at 24 $\pm$ 2 hours after test conclusion	$\pm(0.5\%+0.0005\Omega)$
Bias Humidity MIL-STD-202 Method 103	1,000 hours at 85 $^{\circ}$ C/85%R.H. 10% of operating power, no condensation on the devices, circulating air.	$\pm(1.0\%+0.0005\Omega)$

■ **Packing on Tape and Reel: All specifications are in accordance with IEC 60286-3**

■ **Paper Tape Specifications for WR, WF, WW Series and WA, WT, TA Series**

Unit: mm

Component Size / Series	W	F	E	PO	ΦD
1210, 1206, 0805, 0603, 0402, WA06X, WA06T, WA04X, WA04Y, WA04P, WA04T, WA04U, WT04X	8.00±0.30	3.50±0.20	1.75±0.10	4.00±0.10	Φ1.50+0.1
WA06W	12.0±0.10	5.50±0.05			
WR02X	8.00±0.20	3.50±0.05			

Component Size / Series	A	B	P1	T
1206(3216), WA06X, WA06T	3.60±0.20	2.00±0.20	4.00±0.10	Max. 1.0
0805(2012)	2.40±0.20	1.65±0.20		0.65±0.05
0603(1608)	1.90±0.20	1.10±0.20		0.40±0.05
0402(1005)	1.20±0.10	0.70±0.10	2.00±0.10	0.40±0.05
WA04X, WA04T	2.20±0.20	1.20±0.20	2.00±0.05	Max. 0.6
WA04Y, WA04P, WA04U	1.15±0.10	1.15±0.10	2.00±0.05	0.45±0.05
WT04X	3.45+0.2/-0	1.85+0.2/-0	4.00±0.10	0.85±0.05
WA06W	4.20+0.2/-0	1.80+0.2/-0	4.00±0.10	0.65±0.05
WR02X	0.67±0.05	0.37±0.05	2.00±0.05	0.45±0.05
1210(3225)	3.60±0.20	3.00±0.20	4.00±0.10	Max. 1.0

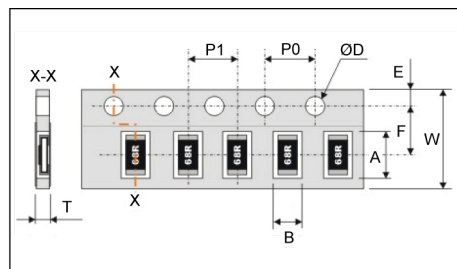
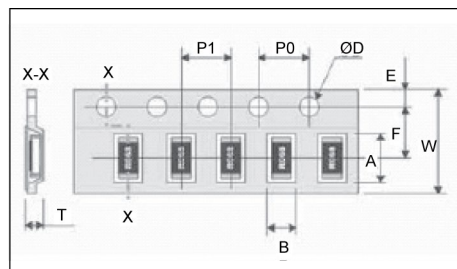
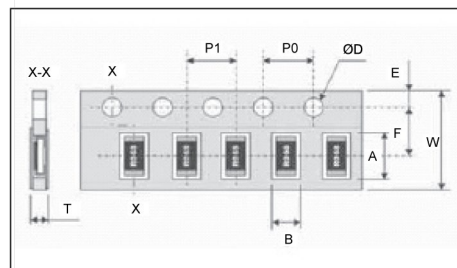

■ **Plastic Tape Specifications for WR, WF, WW, WM Series of Chip-R**

Unit: mm

Component Size	2512(6432)	2010(5025)	1218(3248)
A	6.90±0.20	5.50±0.20	3.55±0.30
B	3.60±0.20	2.80±0.20	4.90±0.20
W	12.00±0.30		
F	5.50±0.10		
E	1.75±0.10		
P1	4.00±0.10	8.00±0.10	
P0	4.00±0.10		
ΦD	Φ1.50+0.1		
T	Max. 1.2		

Component Size	0207 (6123)	0204 (3715)
A	6.15±0.10	3.65±0.10
B	2.40±0.10	1.55±0.10
W	12.00±0.30	8.00±0.30
F	5.50±0.05	3.50±0.05
E	1.75±0.10	1.75±0.10
P1	4.00±0.10	4.00±0.10
P0	4.00±0.10	4.00±0.10
ΦD	Φ1.50+0.1	Φ1.50+0.1
T	2.70±0.10	1.8±0.10

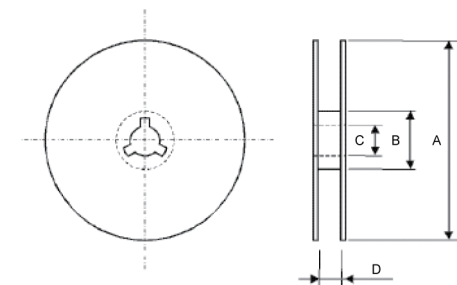

■ **Plastic Tape Reel Specifications for WR, WF, WW, WM Series of Chip-R**

Unit: mm

Reel/Tape	A	B	C	D
7" reel for 8mm tape	Φ178.0±0.20	Φ60.0±1.00	13.0±0.20	9.00±0.50
7" reel for 12mm tape				12.4+2.0/-0
10" reel for 8mm tape	Φ254.0±2.00	Φ100.0±1.00	13.0±0.20	9.00±0.50
10" reel for 12mm tape	Φ254.0±2.00	Φ100.0±1.00	13.0±0.20	12.4+2.0/-0
13" reel for 8mm tape	Φ330.0±2.00	Φ100.0±1.00	13.0±0.20	9.00±0.50

■ **Reel Taping Quantity Specifications for WR, WF, WW, WM Series and WA, WT, TA Series**

Unit: mm

Component Size / Series	Q'ty per reel	Reel Diameter
0603, 0805, 1206	1,000 pcs	4" reel
1210, 1206, 0805, 0603, WA06X, WA06T, WT04X	5,000 pcs	7" reel
0201, 0402, WA04X, WA04Y, WA04P, WA04T, WA04U	10,000 pcs	7" reel
0201, 0402	15,000 pcs	7" reel
01005	20,000 pcs	7" reel
WA06X, WA06Y	5,000 pcs	7" reel
2512, 2010, WW12N, WW12M, WW12J, WW12K	4,000 pcs	7" reel
WM'0207	3,000 pcs	7" reel
WM'0204	2,000 pcs	7" reel
1218	3,000 pcs	10" reel
1210, 1206, 0805, 0603, WA06X, WA06T	10,000 pcs	10" reel
0201, 0402, WA04X, WA04Y	Q: 20,000 pcs/ J: 40,000 pcs	10" reel
2010, 2512	8,000 pcs	10" reel
0201	H: 50,000pcs/ G: 70,000 pcs	13" reel
0402	H: 50,000pcs/ G: 70,000 pcs	13" reel
WA04X, WA04Y	40,000 pcs	13" reel
1210, 1206, 0805, 0603, WA06X,	20,000 pcs	13" reel

■ **Footprint Design**

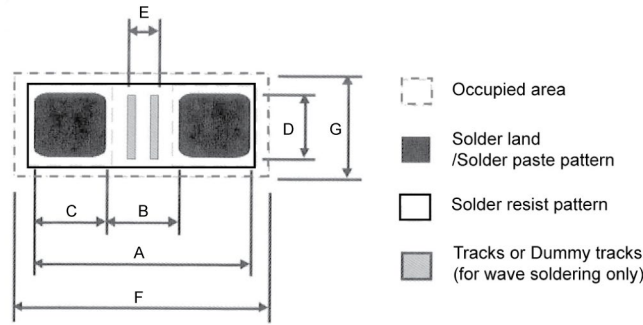

■ **Footprint Design for WRxx, WFxx, WWxx Series**

Size	Reflow Soldering							Processing Remarks	Placement Accuracy
	A	B	C	D	E	F	G		
01005	0.58	0.18	0.20	0.20	0.10	0.90	0.40	IR or hot plate soldering	±0.03
0201	0.90	0.30	0.30	0.30	0.20	1.10	0.50		±0.05
0402	1.50	0.50	0.50	0.60	0.10	1.90	1.00		±0.15
0603	2.10	0.90	0.60	0.90	0.50	2.35	1.45		±0.25
0805	2.60	1.20	0.70	1.30	0.75	2.85	1.90		±0.25
1206	3.80	2.00	0.90	1.60	1.60	4.05	2.25		±0.25
1210	3.80	2.00	0.90	2.80	1.60	4.05	3.15		±0.25
1218	3.80	2.00	0.90	4.80	1.40	4.20	5.50		±0.25
2010	5.60	3.80	0.90	2.80	3.40	5.85	3.15		±0.25
2512	7.00	3.80	1.60	3.50	3.40	7.25	3.85		±0.25

Size	Wave Soldering							Processing Number & Dimensions of dummy tracks	Placement Accuracy
	A	B	C	D	E	F	G		
0603	2.70	0.90	0.90	0.80	0.15	3.40	1.90	1× (0.15 × 0.80)	±0.25
0805	3.40	1.30	1.05	1.30	0.20	4.30	2.70	1× (0.20 × 1.30)	±0.25
1206	4.80	2.30	1.25	1.70	1.25	5.90	3.20	3× (0.25 × 1.70)	±0.25
1210	4.80	2.30	1.25	2.50	1.25	5.90	3.60	3× (0.25 × 1.70)	±0.25
1218	4.80	2.30	1.25	4.80	1.30	5.90	5.60	3× (0.25 × 4.80)	±0.25
2010	6.30	3.50	1.40	2.50	3.00	7.00	3.60	3× (0.75 × 2.50)	±0.25
2512	8.50	4.50	2.00	3.20	3.00	9.00	4.30	3× (1.00 × 3.20)	±0.25

■ **Footprint Design for Array Resistor/Attenuator**

Symbol	Array Resistor/Attenuator						
	0603x4 array	0603x2 array	0402x4 array	0402x2 array	0402x8 array	WA02A	WA02B
A	3.0+0.10/-0.05	1.5+0.10/ -0.05	1.80±0.05	1.20±0.05	3.85±0.05	1.40±0.05	0.80±0.05
B	0.45±0.05	0.45±0.05	0.30±0.05	0.40 +0/ -0.05	0.28 +0/ -0.05	0.20 +0/ -0.05	0.30 +0/ -0.05
D	0.80±0.10	0.80±0.10	0.50±0.10	0.50±0.05	1.00 +0.1/ -0.20	0.30±0.05	0.30±0.05
P	0.8	1.0	0.5	0.65	0.5	0.4	0.5
F	1.90±0.20	1.80±0.20	1.3 +0.20/ -0.10	1.3 +0.20/ -0.10	1.90±0.20	0.9±0.10	0.9±0.10

■ **Footprint Design for 10P8R Network Resistor**

Symbol	WT04X
W1	0.50±0.05
W2	0.35±0.05
H2	0.80±0.10
P1	0.70±0.05
P2	0.65±0.05
A	3.20±0.10
F	2.80 + 0.40 / -0.20

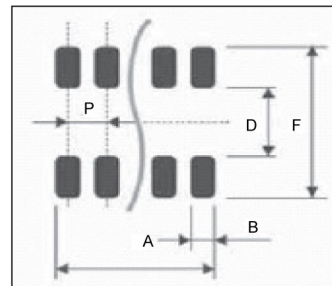

**ARRAY**

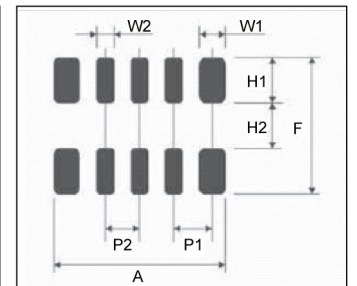

**10P8R**



■ **Storage and Handling Conditions**

1. Products are recommended to be used up within two years since production as ensured shelf life . Check solderability in case shelf life extension is needed.
2. To store products with following condition:  
 Temperature :5 to 40°C  
 Humidity :20 to 70% relative humidity
3. Caution:
  - a. Don't store products in a corrosive environment such as sulfide, chloride gas, or acid. It may cause oxidization of electrode, which easily be resulted in poor soldering
  - b. To store products on the shelf and avoid exposure to moisture.
  - c. Don't expose products to excessive shock, vibration, direct sunlight and so on

■ **Precaution of Soldering**

1. It is recommended to use a mildly activated rosin flux (less than 0.1% wt chlorine )
2. Excessive flux must be avoided
3. When water-soluble flux is used, enough washing is necessary
4. Two times limitations for reflow soldering is highly recommended
5. Solder repair by soldering iron
  - a. Max. 350°C for below 3 seconds is highly recommended
  - b. Do not directly contact termination to avoid thermal shock
6. Prevent any external force on the products until solder is cooled

■ **Mounting**

1. Imperfect adjustment of mounting machine may cause the cracks, the chipping and the alignment error. Check and inspect the mounting machine in advance.
2. Set the backup pins in proper layout otherwise the components mounted on the backside of the board are damaged. Do not set these pins at the position of the nozzle.
3. Adjust the bottom dead point of dispenser away from the board when you apply adhesive.
4. Confirm that the products are corresponding to flow soldering when you perform it.
5. Pay attention to the amount of solder because improper amount of solder place large stress on the products and cause cracks or malfunctions.

■ **Washing**

1. Confirm the ionic residues in solder do not remain after washing for moisture resistance and corrosion. Resistance may cause deterioration when these substances are attached to the products.
2. Confirm the reliability in advance when using no washing solder, water or soluble agent.
3. Wash thoroughly after soldering to remove ionic substances like sweat and salinity.
4. The ultrasonic washing may destruct the products due to resonance by vibration. High hydraulic pressure may also damage the products.
5. Dry the products sufficiently after washing.

■ **Recommendation of Soldering Profiles**

In general application, the lead free (Pb-free) termination CRs are used and may be mounted on PCB by IR reflow or wave soldering process with lead-free solder material. The recommended soldering profiles are shown as Fig.1 & 2. The lead-free termination CRs are also suitable on SMT process against lead-containing solder paste. But the soldering temperature should be higher than the melting point of solder paste 30°C at least. If the optimized solder joint is requested, increasing soldering time, temperature and concentration of N2 within oven are recommended. Advised IR reflow soldering profile is shown as Fig.3.

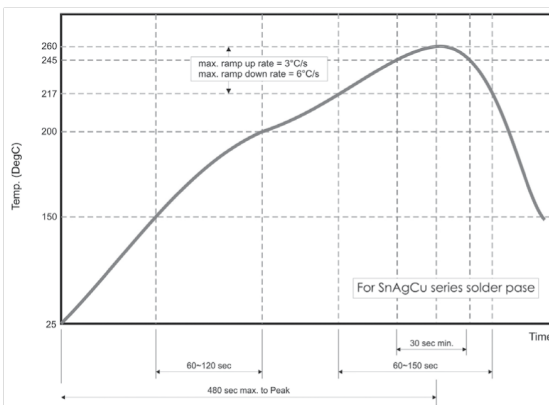

Fig. 1 Recommended IR reflow soldering profile for SMT process with SnAgCu series solder paste

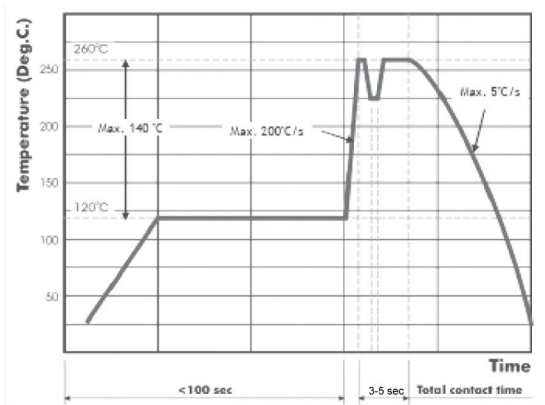

Fig. 2 Recommended wave soldering profile for SMT process with SnAgCu series solder

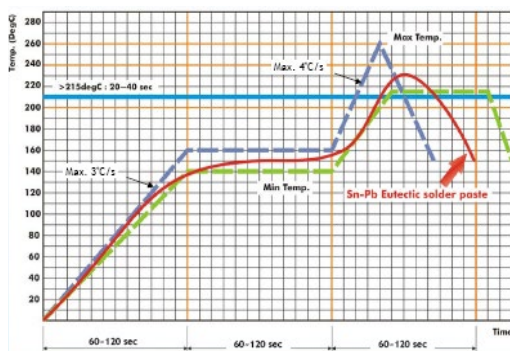

Fig. 3 Recommended reflow soldering profile for SMT process with eutectic SnPb solder paste.

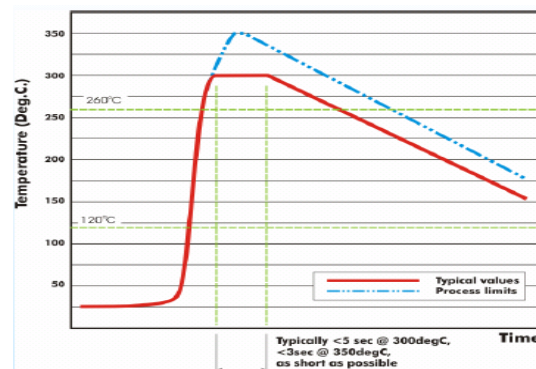

Fig. 4 Recommended soldering profile by manual with SnAgCu series solder material



**Taiwan - Yang-Mei Plant / Sales Office**

Walsin Technology Corporation  
566-1, Kao-Shi Road, Yang-Mei, Tao-Yuan, Taiwan  
Tel: +886-3-475-8711 Fax: +886-3-475-7130 Email: [info@passivecomponent.com](mailto:info@passivecomponent.com)

**China - Dalang Plant / Sales Office**

Dongguan Walsin Tech. Electronics CO., Ltd.  
Xiniu Administrative Zone, Dalang Town, Dongguan City, Guangdong Province 523799  
Tel: +86-769-831-15168 Fax: +86-769-831-15188 Email: [msyu@passivecomponent.com](mailto:msyu@passivecomponent.com)

**China - Suzhou Plant / Sales Office**

Suzhou Walsin Technology Electronics Co., Ltd.  
No. 369, Changyan Street, Suzhou Industrial Park, Jiangsu Province 215126  
Tel: +86-512-628-36888 Fax: +86-512-628-37888 Email: [msyu@passivecomponent.com](mailto:msyu@passivecomponent.com)

**China - Guangzhou Plant / Sales Office**

Pan Overseas (Guangzhou) Electronic Co., Ltd.  
No. 277, Hong Ming Road, Eastern Section, Guangzhou Economic and Technology, Development Zone, China  
Tel: +86-20-8223-7476 Fax: +86-20-8223-7475 Email: [msyu@passivecomponent.com](mailto:msyu@passivecomponent.com)

**Germany - Munich Sales Office**

Walsin Technology Corporation Europe  
Bretonischer Ring 6, Pavillon 3, 85630 Grasbrunn, Germany  
Tel: +49-(0)89-9308-6475 Fax: +49-(0)89-9308-6464 Email: [aw@passivecomponent.com](mailto:aw@passivecomponent.com)

**Singapore - Sales Office**

WTC Singapore Sales Office, Singapore  
24 Sin Ming Lane Midview City, #04-100, Singapore 573970  
Contact: Morris Liew  
Tel: +65-6262 3997 Email: [morisliew@sg.passivecomponent.com](mailto:morrisliew@sg.passivecomponent.com)

**Malaysia - Sales Office**

Walsin Technology Corporation, Malaysia  
1st Floor, No.19, Jalan Puteri 5/8, Bandar Puteri Puchong, Puchong, 47100, Selangor, Malaysia  
Contact: Arthur Ling  
Tel : +6016-2217-948 Fax : +603-8051-7060 Email : [arthurling@passivecomponent.com](mailto:arthurling@passivecomponent.com)

**United States - West Coast Sales Office**

Walsin Technology Corporation, USA  
Contact: FC Tseng  
Tel: +1-214-708-5182 E-mail: [fctseng@passivecomponent.com](mailto:fctseng@passivecomponent.com)

**JAPAN - Sales Office**

PSA BLDG. 3F, 6-1-6 Chuou, Yamato-Shi, Kanagawa, 242-0021 Japan  
Tel:+81-46-204-8829 Fax:+81-46-204-8955 Email: [tsakano@kamaya.co.jp](mailto:tsakano@kamaya.co.jp)

**PSA** PASSIVE SYSTEM ALLIANCE  
WALSIN TECHNOLOGY CORPORATION